

STORE FAIFA

จำหน่ายอุปกรณ์ติดตั้งงานไฟฟ้าทุกชนิด

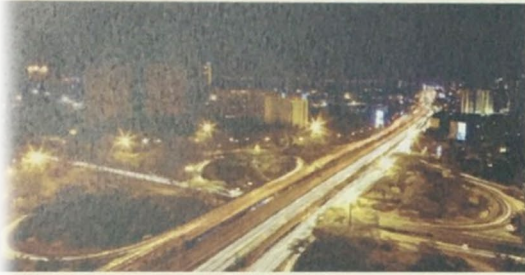

MV/HV FUSE & SWITCH ,TOOLS
ARRESTER , CT & PT , CAPACITOR
CABLE & HARDWARE ACCESSORIES
HYDRAULIC TOOLS & SAFETY TOOLS
CABLE ACCESSORIES , INSULATOR

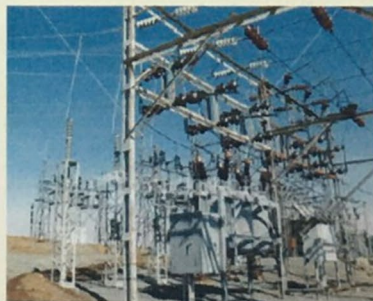

PRODUCT CATALOGUE 2021

บริษัท สโตร์ไฟฟ้า จำกัด

STORE FAIFA COMPANY LIMITED

55/42 หมู่ 3 ตำบลลำลูกกา อำเภอลำลูกกา จังหวัดปทุมธานี 12150

E-mail : storefaifaoffice@gmail.com , www.storefaifa.com

Tel : 02-150-1988 Fax : 02-150-1989

PRODUCT GROUP : A

INSULATOR , CABLE & HARDWARE ACCESSORIES



[A101] Spool Insulator ลูกถ้วยแรม

Code No.	ANSI Class	Price(ราคา)	Note
A101-IN01	53-2	30	



[A102] Station Post Insulator ลูกถ้วยทีอาร์

Code No.	TR. (No.)	Rated (kV.)	Price(ราคา)	Note
A102-IN01	202	7.2	สอบถาม	
A102-IN02	205	11		
A102-IN03	208	22		
A102-IN04	210	33		
A102-IN05	216	69		
A102-IN06	286	115		



[A103] Pillow Insulator ลูกถ้วยหมอน

Code No.	Size	Length (mm.)	Price(ราคา)	Note
A103-IN01	UCS-001	95	290	
A103-IN02	UCS-003	150	700	
A103-IN03	UCS-004	280	1200	



(A104) Strain Insulator ลูกถ้วยยึดโยง

Code No.	ANSI Class	Length(inch)	Strength (Lbs)	Price(ราคา)	Note
A104-IN01	54-1	3½	10000	65	
A104-IN02	54-2	4½	12000	90	
A104-IN03	54-3	5½	20000	130	
A104-IN04	54-4	6½	20000	160	



(A105) Wire Holder ลูกถ้วยหางหนู

Code No.	Size	Price(ราคา)	Note
A105-IN01	Small	10	
A105-IN02	Medium	15	
A105-IN03	Large	80	



(A106) Suspension Insulator ลูกถ้วยแขวน

Code No.	ANSI Class	Type	Disc (Dia inch)	Price(ราคา)	Note
A106-IN01	52-1	Clevis & Eye	6	500	
A106-IN02	52-2	Clevis & Eye	7½	850	
A106-IN03	52-4	Clevis & Eye	10	1300	
A106-IN04	52-3	Ball & Socket	10	1300	
A106-IN05	52-8	Ball & Socket	10	2900	

PRODUCT GROUP : A

INSULATOR , CABLE & HARDWARE ACCESSORIES



(A107) Insulator Pin Type ลูกถ้วยก้านตรง

Code No.	ANSI Class	Rated kV	Disc (Dia inch)	Price(ราคา)	Note
A107-IN01	56-2	24	9	สอบถาม	
A107-IN02	56-3	33	10½	สอบถาม	



(A108) Line Post Insulator ลูกถ้วยไลน์โพลท์

Code No.	ANSI Class	Rated kV	Price(ราคา)	Note
A108-IN01	57-2L	24	1100	
A108-IN02	57-3L	33	2500	
A108-IN03	57-4L	46	3800	



(A109) Pin Post Insulator ลูกถ้วยพินโพลท์

Code No.	ANSI Class	Rated kV	Price(ราคา)	Note
A109-IN01	56/57-2L	24	2300	
A109-IN02	56/57-4L	33	3000	



(A110) Fog Insulator Pin Type ลูกถ้วยก้านตรงแบบฟ็อกไทป์

Code No.	ANSI Class	Rated kV	Price(ราคา)	Note
A110-IN01	-	33	สอบถาม	



(A111) Polymer composite Insulator ลูกถ้วยแขวนโพลีเมอร์

Code No.	Rated kV	Price(ราคา)	Note
A111-IN01	22	2000	
A111-IN02	33	3000	



[A112] Cast Resin Insulator ลูกถ้วยแบบ Cast Resin

Code No.	Type	Price(ราคา)		Leakage Distance mm.	Weight (kg.)	Note
		kV	kV.BIL			
A112-IN01	IGn3	3.6	60	145	0.40	
A112-IN02	IGn6	7.2	60	195	0.55	
A112-IN03	IGn10	12	75	235	0.62	
A112-IN04	IGn20	24	125	390	1.25	
A112-IN05	IGn30	36	170	550	1.85	

PRODUCT GROUP : A

HIGH VOLTAGE CABLE

[A113] Aluminium Stranded Conductor Partially Insulated Cable Type Pic

สายพลาเซิล



Code No.	Cable Size (sq.mm.)	Rated 25kV	Rated 35kV	Note
		Price	Price	
A113-CD01	25	สอบตาม	สอบตาม	
A113-CD02	35			
A113-CD03	50			
A113-CD04	70			
A113-CD05	95			
A113-CD06	120			
A113-CD07	150			
A113-CD08	185			
A113-CD09	240			

[A114] Aluminium Stranded Conductor Spaced Aerial Cable Cross-Linked

Polyethylened Insulated and Sheathed Type SAC สายแอร์เรียด



Code No.	Cable Size (sq.mm.)	Rated 25kV	Rated 35kV	Note
		Price	Price	
A114-CD01	25	125	140	
A114-CD02	35	130	145	
A114-CD03	50	137	165	
A114-CD04	70	180	186	
A114-CD05	95	202	206	
A114-CD06	120	238	241	
A114-CD07	150	260	288	
A114-CD08	185	275	303	
A114-CD09	240	334	366	

[A115] Copper Stranded Conductor Cross-Linked Polyethylened

Insulated High Voltage Cable Type XLPE สายใต้ดิน



Code No.	Cable Size (sq.mm.)	Rated 25kV	Rated 35kV	Note
		Price	Price	
A115-CD01	25	-	-	
A115-CD02	35	438	602	
A115-CD03	50	515	633	
A115-CD04	70	620	746	
A115-CD05	95	757	889	
A115-CD06	120	896	1026	
A115-CD07	150	1028	1174	
A115-CD08	185	1209	1362	
A115-CD09	240	1515	1656	

PRODUCT GROUP : A

LV , MV , HV CONDUCTORS



[A116] Aluminum Conductors Insulated and Bare
สายอลูมิเนียมหุ้มและสายอลูมิเนียมเปลือย

Code No.	Cable Size (sq.mm.)	Type THW-A	Type AAC	Type ACSR	Note
		Price/M.	Price/M.	Price/M.	
A116-CD01	6	-	-	-	
A116-CD02	10	9.08	สอบถาม	สอบถาม	
A116-CD03	16	12.32			
A116-CD04	25	18.17			
A116-CD05	35	23.48			
A116-CD06	50	31.64			
A116-CD07	70	49.66			
A116-CD08	95	64.88			
A116-CD09	120	79.33			
A116-CD10	150	96.46			
A116-CD11	185	120.06			
A116-CD12	240	157.03			
A116-CD13	300	192.08			
A116-CD14	400	สอบถาม			
A116-CD15	500	สอบถาม			

[A117] Ground Wire Cable สายกราวด์



Code No.	Size (AWG)	Price/150 M.	Note
A117-CD01	6	สอบถาม	
A117-CD02	10		
A117-CD03	14		



[A118] Drop Wire Cable สายตรอปไวร์

Code No.	Size (sq.mm.)	Price/150 M.	Note
A118-CD01	2Cx0.5	สอบถาม	
A118-CD02	2Cx0.65		



[A119] Jumper Wire Cable สายจัมเปอร์

Code No.	Size (sq.mm.)	Price/150 M.	Note
A119-CD01	2Cx0.5	สอบถาม	
A119-CD02	2Cx0.65		

PRODUCT GROUP : A

LV , MV , HV CONDUCTORS

[A120] Bare Copper Conductors
สายทองแดงเปลือย



Code No.	Size (sq.mm.)	Price	Note	Size (sq.mm.)	Price	Note
A120-CD01	10	49.3		120	572	
A120-CD02	16	76.5		150	700	
A120-CD03	25	120		185	879	
A120-CD04	35	170.5		240	1153	
A120-CD05	50	229.2		300	1445	
A120-CD06	70	327.7		400	1850	
A120-CD07	95	451.5		500	2395	



[A121] Steel Strand Wire ลวดเหล็กตีเกลียว

Code No.	Grade Utility Size (sq.mm.)	Strand	Price/เมตร	Note
A121-CD01	4	Solid	-	
A121-CD02	25	7	22	
A121-CD03	35	7	29	
A121-CD04	50	7	39	
A121-CD05	95	19	78	

[A122] Steel Strand Wire ลวดเหล็กตีเกลียวรุ่นเอ็กซ์ตรา

Code No.	Grade Utility Size (inch)	Strand	Price/เมตร	Note
A122-CD01	1 1/4	7	23	
A122-CD02	5/16	7	37	
A122-CD03	3/8	7	44	
A122-CD04	7/16	7	100	
A122-CD05	1/2	7	สอบถาม	

PRODUCT GROUP : A

PREFORMED PRODUCT



[A123] Preformed Dead End (For Aluminum Conductors Insulated)
สำหรับสายอลูมิเนียมหุ้ม

Code No.	สาย THW-A	PIC 25kV	PIC 25kV	SAC 25kV	SAC 35kV	Price	Note
	Size (sq.mm.)						
A123-PM01	16					16	
A123-PM02	25					25	
A123-PM03	35					35	
A123-PM04	50	35				50	
A123-PM05	70	50	35			70	
A123-PM06	95	70	50			95	
A123-PM07	120	95	70			120	
A123-PM08	150	120-150	95			150	
A123-PM09	185	185	20-150	35-50		185	
A123-PM10	240	-	185	70-95	50	240	
A123-PM11	300	-	-	120-150	70-95	300	
A123-PM12	400	-	-	185	120-150	400	
A123-PM13	500	-	-	240	185-240	500	

[A124] Preformed Dead End (For Bare Conductors)
สำหรับสายเปลือย

Code No.	Size (sq.mm.)	Price	Note
A124-PM01	25	102	
A124-PM02	35	134	
A124-PM03	1AWG	สอบถาม	
A124-PM04	50	208	
A124-PM05	70	218	
A124-PM06	95	282	
A124-PM07	120	370	
A124-PM08	150	500	
A124-PM09	185	645	
A124-PM10	240	1270	
A124-PM11	300	1450	
A124-PM12	400	1950	
A124-PM13	500	2750	

PRODUCT GROUP : A

PREFORMED PRODUCT



[A125] Preformed Line Guard **พรีฟอร์มไลน์การ์ด**

Code No.	Size (sq.mm.)	Price	Note
A125-PM01	25	80	
A125-PM02	35	98	
A125-PM03	50	116	
A125-PM04	70	150	
A125-PM05	95	190	
A125-PM06	120	217	
A125-PM07	150	300	
A125-PM08	185	350	
A125-PM09	240	460	

[A126] Preformed Armour Rode **พรีฟอร์มอาร์มเมอร์รอด**

Code No.	Size (sq.mm.)	Price	Note
A126-PM01	35	217	
A126-PM02	50	283	
A126-PM03	70	44	
A126-PM04	95	520	
A126-PM05	120	650	
A126-PM06	185	982	
A126-PM07	240	1475	
A126-PM08	400	2540	
A126-PM09	625	4425	

[A127] Preformed Guy Grips Dead End **พรีฟอร์มกายกริปเด็ตเอน**



Code No.	Size inch (inch)	Price	Note
A127-PM01	5/32"	สอบถาม	
A127-PM02	3/16"	60	
A127-PM03	1/4"	92	
A127-PM04	5/16"	120	
A127-PM05	3/8"	162	
A127-PM06	7/16"	สอบถาม	
A127-PM07	1/2"	482	

PRODUCT GROUP : A

PREFORMED PRODUCT

[A128] Preformed Guy Grips For Insulator
 PREFORMED กายกริปฟอว์อินซูเลเตอร์



Code No.	Size inch (inch)	Price	Note
A128-PM01	1/4(4M)	100	
A128-PM02	5/16(6M)	123	
A128-PM03	3/8(10M)	166	

[A129] Preformed False Dead End
 PREFORMED กายกริปฟอลซ์เด็เดเอน



Code No.	Size inch (inch)	Price	Note
A129-PM01	1/4(4M)	102	
A129-PM02	5/16(6M)	130	
A129-PM03	3/8(10M)	170	

[A130] Preformed Stranded Splice
 PREFORMED สแตนดึสไปรซ์



Code No.	Size inch (inch)	Price	Note
A130-PM01	1/4(4M)	98	
A130-PM02	5/16(6M)	122	
A130-PM03	3/8(10M)	168	

[A131] Preformed Spiral Vibration Damper
 PREFORMED สไปรึลไวรึเบรชึนดึมเปอริ



Code No.	Size (sq.mm.)	Price	Note
A131-PM01	50-70	สอบถาม	
A131-PM02	95-120	สอบถาม	
A131-PM03	150-185	สอบถาม	

[A132] Preformed Spiral Vibration Damper
 PREFORMED สไปรึลไวรึเบรชึนดึมเปอริ



Code No.	Dimeter Range		Price	Note
	MIN(mm.)	MAX(mm.)		
A132-PM02	400		สอบถาม	

PRODUCT GROUP : A

PREFORMED PRODUCT

[A133] Composite Ties **พรีฟอร์มกายนกริปฟอร์อินซูเลเตอร์**

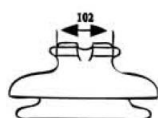

Pin Type 56-2
Pin Type 56-3

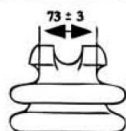

Line Post 57-2
Line Post 57-3
Pin Post 56/57-
Pin Post 56/57-



Composite Ties

Code No.	Insulator	Cable Range O.D.(mm.)	Price	Note
A133-PM01	120-117.47 "C"Neck	6.35-10.31	สอบถาม	
A133-PM02		10.33-14.25		
A133-PM03		14.27-18.21		
A133-PM04		18.23-23.59		
A133-PM05		28.60-38.10		
A133-PM06		6.35-10.31		
A133-PM07	69.85-85.72 "C"Neck	6.35-10.31	สอบถาม	
A133-PM08		10.33-14.25		
A133-PM09		14.27-18.21		
A133-PM10		18.23-23.34		
A133-PM11		23.36-28.59		
A133-PM12		28.60-38.10		

PRODUCT GROUP : A

ALUMINUM CONNECTORS

[A134] Full Tension Splice For Aluminium Conductor

หลอดต่อสายอลูมิเนียมชนิดรับแรงดึง



Code No.	Size (sq.mm.)	Length (mm.)	Price	Note
A134-AC01	25	140	32	
A134-AC02	35	140	42	
A134-AC03	50	155	55	
A134-AC04	70	165	64	
A134-AC05	95	165	80	
A134-AC06	120	250	114	
A134-AC07	150	300	150	
A134-AC08	185	330	175	
A134-AC09	240	350	340	
A134-AC10	300	380	660	
A134-AC11	400	380	720	
A134-AC12	625	450	สอบถาม	

[A135] Partial Tension Splice For Aluminium Conductor

หลอดต่อสายอลูมิเนียมชนิดไม่รับแรงดึง



Code No.	Size (sq.mm.)	Length (mm.)	Price	Note
A135-AC01	25	85	24	
A135-AC02	35	85	32	
A135-AC03	50	85	44	
A135-AC04	70	105	50	
A135-AC05	95	105	72	
A135-AC06	120	105	82	
A135-AC07	150	125	90	
A135-AC08	185	125	102	
A135-AC09	240	145	180	
A135-AC10	300	280	400	
A135-AC11	400	280	600	
A135-AC12	625	350	สอบถาม	

[A136] Pin-Terminal พินเทอร์มินอล



Code No.	Size (sq.mm.)	Price	Note
A136-AC01	50	80	
A136-AC02	70	95	
A136-AC03	95	160	
A136-AC04	120	195	
A136-AC05	185	230	

PRODUCT GROUP : A

ALUMINUM CONNECTORS

[A137] Full Tension Splice for ACSR Conductor

หลอดต่อสายอลูมิเนียมแกนเหล็กชนิดรับแรงดึง



Code No.	Size (sq.mm.)	Length (mm.)	Price	Note
A137-AC01	35	350	สอบถาม	
A137-AC02	50	440	สอบถาม	
A137-AC03	70	480	สอบถาม	
A137-AC04	95	500	สอบถาม	
A137-AC05	120	500	สอบถาม	
A137-AC06	150	520	สอบถาม	
A137-AC07	185	540	สอบถาม	
A137-AC08	240	660	สอบถาม	
A137-AC09	300	660	สอบถาม	
A137-AC10	400	660	สอบถาม	
A137-AC11	625	700	สอบถาม	

[A138] Aluminium Compression Terminal Lug NEMA Hole

หางปลาลูมิเนียมเจาะรูตามมาตรฐาน นีมา



Code No.	Size (sq.mm.)	Price (1 Hole)	Price (2 Hole)	Price (4Hole)	Note
A138-AC01	25	สอบถาม	44	44	
A138-AC02	35	สอบถาม	48	48	
A138-AC03	50	สอบถาม	56	56	
A138-AC04	70	สอบถาม	72	72	
A138-AC05	95	สอบถาม	84	84	
A138-AC06	120	สอบถาม	135	135	
A138-AC07	150	สอบถาม	159	159	
A138-AC08	185	สอบถาม	168	168	
A138-AC09	240	สอบถาม	225	225	
A138-AC10	300	สอบถาม	800	800	
A138-AC11	400	สอบถาม	1200	1200	
A138-AC12	625	สอบถาม	สอบถาม	สอบถาม	

[A139] Strain Clamp With Clamping Keeper

สเตรนแคลมป์พร้อมแคลมป์ปั๊มป์คิปเปอร์



Code No.	Size (sq.mm.)	Price	Note
A139-AC01	70-95	340	
A139-AC02	120	380	
A139-AC03	150	1150	
A139-AC04	185-240	1150	
A139-AC05	400	1600	
A139-AC06	625	สอบถาม	

PRODUCT GROUP : A

ALUMINUM CONNECTORS

[A140] Strain Clamp Straight Tye
สเตรนแคลมป์แบบตรง



Code No.	Size (sq.mm.)		Price	Note
	AAC	ACSR		
A140-AC01	35-70	35-70	220	
A140-AC02	95	70	350	
A140-AC03	120	95	350	
A140-AC04	150	120	450	
A140-AC05	185	150	450	

[A141] PG Clamp Connector, Bolt Type
พีจี คอนเนคเตอร์



Code No.	Size (sq.mm.)	Price (1 Bolt)	Price (2 Bolt)	Price (3 Bolt)	Note
A141-AC01	16-70		35		
A141-AC02	25-95		40		
A141-AC03	70-185			130	
A141-AC04	95-240			180	

[A142] Bimetallic P.G. Clamp Connector
พีจี แคลมป์สำหรับใช้กับสาย AL/CU



Code No.	Size (sq.mm.)	Price	Note
A142-AC01	CU-16 / Al-70	สอบถาม	

[A143] Parallel Groove Clamp Connector
พีจี แคลมป์แบบมือเสือ



Code No.	Size (sq.mm.)	Price (1 Bolt)	Price (2 Bolt)	Note
A143-AC01	50-120		150	
A143-AC02	50-185		165	

[A144] Dead End Connector
คอนเนคเตอร์เข้าปลายสาย



Code No.	Size (sq.mm.)	Price	Note
A144-AC01	25-35	45	
A144-AC02	50-70	65	
A144-AC03	95-120	130	

[A145] Compression Connectors ' H ' Type
แคลมป์อลูมิเนียม เอชไทป์ ชนิดบีบ



Code No.	Size (sq.mm.)	Price	Note
A145-AC01	10-16/4-10	18	
A145-AC02	25-50/2.5-6	25	
A145-AC03	25-50/16-35	35	
A145-AC04	35-50/6-10	40	
A145-AC05	70-95/16-35	45	
A145-AC06	50-95/50-95	50	

PRODUCT GROUP : A

ALUMINUM CONNECTORS



[A146] Piercing Hotline Clamp
เพียรชิ่ง ฮอทไลน์ แคลมป์

Code No.	Insulation Thrickness	Cable Range	Price	Note
A146-AC01	Max.6mm	RUN12.7-29mm. Tap4-1/0 AWG	สอบถาม	



[A147] Bail Clamp (Stirrup Clamp)
เบล แคลมป์

Code No.	Size (sq.mm.)	Price	Note
A147-AC01	25-50	480	
A147-AC02	70-185	680	



[A148] Hot line Clamp
ฮอทไลน์ แคลมป์

Code No.	Size (sq.mm.)	Price	Note
A148-AC01	25-50	350	
A148-AC02	50-120	550	



[A149] Tie Wire
ลวดอลูมิเนียมกลม

Code No.	Size (sq.mm.)	Price	Note
A149-AC01	4	300	



[A150] Tie Wire
ลวดอลูมิเนียมกลม

Code No.	Size (mm.)	Price	Note
A150-AC01	1x10	330	

PRODUCT GROUP : A

STEEL CROSSARM(HOT DIP GALVANIZED)



[A151] Crossarm Steel Channel คอนเหล็กรูปร่างน้ำ

Code No.	Size (sq.mm.)	Length (mm.)	Price	Note
A151-SC01	100x50x5	2500	2300	
A151-SC02	125x65x6	2500	สอบถาม	
A151-SC03	125x65x6	3000	สอบถาม	
A151-SC04	100x50x5	4200	3500	
A151-SC05	150x75x6.5	4000	สอบถาม	
A151-SC06	150x75x6.5	4500	สอบถาม	
A151-SC07	150x75x6.5	6000	สอบถาม	
A151-SC08	200x80x7.5	1000	สอบถาม	
A151-SC09	200x80x7.5	6000	สอบถาม	



[A152] Brace Steel Angel คอนเหล็กฉาก

Code No.	Size (sq.mm.)	Length (mm.)	Price	Note
A152-SC01	65x65x6	1000	สอบถาม	
A152-SC02	75x75x6	3500		
A152-SC03	75x75x6	4100		
A152-SC04	75x75x6	4500		
A152-SC05	100x100x7	4200		
A152-SC06	150x150x12	4500		
A152-SC07	150x150x12	5000		



[A153] Steel Channel Alley Arm คอนเหล็กท้าวแขนแบบรางน้ำ

Code No.	Size (sq.mm.)	Length (mm.)	Price	Note
A153-SC01	100x50x5	2250	สอบถาม	



[A154] Brace Alley Arm เหล็กท้าวแขนข้างเดียว

Code No.	Size (sq.mm.)	Length (mm.)	Price	Note
A154-SC01	40x40x5	2120	750	
A154-SC02	50x50x5	2350	1080	

PRODUCT GROUP : A

HARDWARE & ACCESSORIES



[A155] Galvanized Ground Rod กราวด์รอตชุบสังกะสี

Code No.	Length (mm.)	Price (Size M-12)	Price (Size M-16)	Note
A155-HW01	1000	120	180	
A155-HW02	1500	180	200	
A155-HW03	1800		280	
A155-HW04	2000		330	
A155-HW05	2400		380	
A155-HW06	3000		450	



[A156] Earthing Spike กราวด์รอตสี่แฉก

Code No.	Size (sq.mm.)	Length (mm.)	Price	Note
A156-HW01	60x60x5	2000	850	



[A157] Brace Angel Steel เหล็กทำว้านแบบเขาควาง

Code No.	Size (sq.mm.)	Width (mm.)	Length (mm.)	Price	Note
A157-HW01	50x50x6	1500	450	สอบถาม	
A157-HW02	50x50x6	1800	450	1200	



[A158] Overhead Ground Wire Bayonet เหล็กโอเวอร์เฮด

Code No.	Size (sq.mm.)	Price	Note
A158-HW01	Overhead Bayonet 65x65x6 mm.3,000mm.	สอบถาม	
A158-HW02	Corner Bayonet 65x65x6 mm.2,850mm.		
A158-HW03	Overhead Bayonet 65x65x6 mm.2,500mm.		
A158-HW04	Corner Bayonet 65x65x6 mm.2,150mm.		
A158-HW05	Overhead Bayonet 65x65x6 mm.2,250mm.		
A158-HW06	Corner Bayonet 65x65x6 mm.2,100mm.		
A158-HW07	Dead-end Bayonet 100x50x5 mm.2,250mm.		
A158-HW08	Dead-end Bayonet 100x50x5 mm.2,500mm.		

PRODUCT GROUP : A

HARDWARE & ACCESSORIES



[A159] เหล็กคองเคเบิลอากาศทางตรง (สระอา)

Code No.	List	Price	Note
A159-HW01	Bracket aerial for straight type	850	



[A160] เหล็กคองเคเบิลอากาศทางโค้ง(ป.ปลา)

Code No.	List	Price	Note
A160-HW01	Bracket aerial for corner size 750 mm.	สอบถาม	
A160-HW02	Bracket aerial for corner size 900 mm.	สอบถาม	
A160-HW03	Bracket aerial for corner size 1,000 mm.	สอบถาม	



[A161] เคเบิลสเปเซอร์สำหรับสายเคเบิลอากาศ

Code No.	Type	Price	Note
A161-HW01	Polythylene	800	
A161-HW02	Alumina Ceramic	2300	



[A162] เหล็กรับคานหม้อแปลง

Code No.	Type	Price	Note
A162-HW01	Support Transformer	1500	



[A163] อายนัทรุ่นย่น

Code No.	Eye Nut Forged Type Size	Price	Note
A163-HW01	M 16	60	
A163-HW02	M 20	สอบถาม	



[A164] อายนัทรุ่นเชื่อม

Code No.	Eye Nut Welded Type Size (inch)	Price	Note
A164-HW01	5/8	สอบถาม	
A164-HW02	3/4	สอบถาม	



[A165] แผ่นห้วงสำหรับสายยึดโยง 30 องศา

Code No.	List	Price	Note
A165-HW01	Angle guy attachment 30°	60	



[A166] กายทิมเบิลสำหรับสายยึดโยง 50-95 มม²

Code No.	List	Price	Note
A166-HW01	Guy Thimble for steel wire 50-95 sq.mm.	15	



[A167] ทิมเบิลเคลวิสสำหรับพรีฟอร์มเข้าปลายสาย

Code No.	List	Price	Note
A167-HW01	Thimble clevis Pin Diameter 16mm.	80	

PRODUCT GROUP : A

HARDWARE & ACCESSORIES



[A168] Double Arming Bolt สลักเกลียวตลอด

Code No.	Length (ความยาว)		Price (Size 5/8")	Price (Size 24mm.)	Note
	inch	mm.			
A168-HW01	12	300	73		
A168-HW02	14	350	80		
A168-HW03	16	400	87		
A168-HW04	18	450	95		
A168-HW05	20	500	102		
A168-HW06	22	550	109		
A168-HW07	24	600	116	330	
A168-HW08	26	650	124		
A168-HW09	32	800		380	
A168-HW10	40	1000		440	
A168-HW11	50	1250		600	



[A169] Machine Bolt สลักเกลียวอบสังกะสี

Code No.	Length (ความยาว)		Price (Size 1/2")	Price (Size 5/8")	Price (Size 3/4")
	inch	mm.			
A169-HW01	2	50	18	30	
A169-HW02	3	75		32	
A169-HW03	5	130	30	33	
A169-HW04	6	150	32	36	
A169-HW05	7	170	36	41	
A169-HW06	8	200	38	45	82
A169-HW07	10	250	45	52	90
A169-HW08	12	300	50	56	98
A169-HW09	14	350	56	63	107
A169-HW10	16	400	64	70	120
A169-HW11	18	450		78	133
A169-HW12	20	500		86	145
A169-HW13	22	550		92	158
A169-HW14	24	600		100	185
A169-HW15	26	650		108	
A169-HW16	28	-			

PRODUCT GROUP : A

HARDWARE & ACCESSORIES



[A170] Angle Thimble Eye Bolt สลักเกลียวห่วงหัวลิง 45 องศา(โค้ง)

Code No.	Length (ความยาว)		Price (Size 5/8")	Price (Size M16)	Note
	inch	mm.			
A170-HW01	6	150	93		
A170-HW02	8	200	101		
A170-HW03	10	250	109		
A170-HW04	12	300	117		
A170-HW05	14	350	129		
A170-HW06	16	400	139		
A170-HW07	18	450			
A170-HW08	20	500			
A170-HW09	22	550			
A170-HW10	24	600			

[A171]

Straight Thimble Bolt

สลักเกลียวห่วงหัวลิง (ตรง)



Code No.	Length (ความยาว)		Price (Size 5/8")	Note
	inch	mm.		
A171-HW01	6	150	88	
A171-HW02	8	200	97	
A171-HW03	10	250	104	
A171-HW04	12	300	116	
A171-HW05	14	350	125	
A171-HW06	16	400	130	
A171-HW07	18	450	146	
A171-HW08	20	500		
A171-HW09	22	550		
A171-HW10	24	600		
A171-HW07	18	450		
A171-HW08	20	500		
A171-HW09	22	550		
A171-HW10	24	600		

[A172] Anchor Rod (Welded Type) สมอบกชนิดเชื่อม



Code No.	Length / Size		Price	Note
	Feet (mm.)	Size		
A172-HW01	5(1500)	5/8"	250	
A172-HW02	6(1800)	5/8"	300	
A172-HW03	7(2000)	5/8"	350	
A172-HW04	8(2400)	5/8"	480	
A172-HW05	10(3000)	5/8"	550	

PRODUCT GROUP : A

HARDWARE & ACCESSORIES



[A172] Anchor Rod (Welded Type) สมอบกชนิดเชื่อม

Code No.	Length / Size		Price	Note
	Feet (mm.)	Size		
A172-HW06	5(1500)	3/4"	สอบถาม	
A172-HW07	6(1800)	3/4"		
A172-HW08	7(2000)	3/4"		
A172-HW09	8(2400)	3/4"		
A172-HW10	10(3000)	3/4"		
A172-HW11	5(1500)	M16		
A172-HW12	6(1800)	M16		
A172-HW13	7(2000)	M16		
A172-HW14	8(2400)	M16		
A172-HW15	10(3000)	M16		
A172-HW16	5(1500)	M20		
A172-HW17	6(1800)	M20		
A172-HW18	7(2000)	M20		
A172-HW19	8(2400)	M20		
A172-HW20	10(3000)	M20		

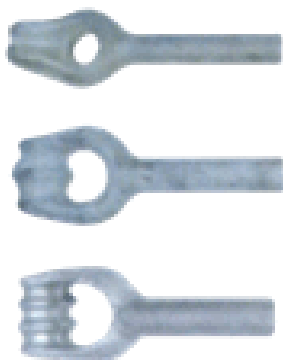

[A173] Thimble Anchor Rod สมอบกชนิด 1 ร่อง 2 ร่อง 3 ร่อง

Code No.	Length / Size		Price	Note
	Feet (mm.)	ร่อง / Size		
A173-HW01	5(1500)	1 ร่อง / 5/8"	สอบถาม	
A173-HW02	6(1800)	1 ร่อง / 5/8"		
A173-HW03	7(2000)	1 ร่อง / 5/8"		
A173-HW04	8(2400)	1 ร่อง / 5/8"		
A173-HW05	10(3000)	1 ร่อง / 5/8"		
A173-HW06	5(1500)	1 ร่อง / M16		
A173-HW07	6(1800)	1 ร่อง / M16		
A173-HW08	7(2000)	1 ร่อง / M16		
A173-HW09	8(2400)	1 ร่อง / M16		
A173-HW10	10(3000)	1 ร่อง / M16		
A173-HW11	5(1500)	2 ร่อง / M20		
A173-HW12	6(1800)	2 ร่อง / M20		
A173-HW13	7(2000)	2 ร่อง / M20		
A173-HW14	8(2400)	2 ร่อง / M20		
A173-HW15	10(3000)	2 ร่อง / M20		
A173-HW16	5(1500)	3 ร่อง / M24		
A173-HW17	6(1800)	3 ร่อง / M24		
A173-HW18	7(2000)	3 ร่อง / M24		
A173-HW19	8(2400)	3 ร่อง / M24		
A173-HW20	10(3000)	3 ร่อง / M24		

PRODUCT GROUP : A

HARDWARE & ACCESSORIES



[A174] Eye Bolt สลักห่วงกลม

Code No.	Length (ความยาว)	Size	Price	Note
	inch (mm.)			
A174-HW01	4(100)	Size 5/8" Weld type แบบเชื่อม	สอบถาม	
A174-HW02	6(150)			
A174-HW03	8(200)			
A174-HW04	10(250)			
A174-HW05	12(300)			
A174-HW06	14(350)			
A174-HW07	4(100)	Size M-16 Forged Type รุ่นย่น	สอบถาม	
A174-HW08	6(150)			
A174-HW09	8(200)			
A174-HW10	10(250)			
A174-HW11	12(300)			
A174-HW12	14(350)			

[A175] Bolt Double Arming Round Eye สลักห่วงเกลียวตลอด

Code No.	Length (ความยาว)	Size	Price	Note
	inch (mm.)			
A175-HW01	16(400)	Size 5/8" Weld type แบบเชื่อม	-	
A175-HW02	18(450)		75	
A175-HW03	20(500)		84	
A175-HW04	22(550)		91	
A175-HW05	24(600)		99	
A175-HW06	26(650)		112	
A175-HW07	16(400)	Size M-16 Forged Type รุ่นย่น	สอบถาม	
A175-HW08	18(450)			
A175-HW09	20(500)			
A175-HW10	22(550)			
A175-HW11	24(600)			
A175-HW12	26(650)			

[A176] Over Eye Bolt สลักห่วงโอเวอร์



Length (ความยาว)	Code No. Size 5/8" Weld type แบบเชื่อม	Price	Code No. Size M-16 Forged Type รุ่นย่น	Price	Note
6(150)	A176-HW1	105	A176-HW11	สอบถาม	
8(200)	A176-HW2	115	A176-HW12		
10(250)	A176-HW3	128	A176-HW13		
12(300)	A176-HW4	138	A176-HW14		
14(350)	A176-HW5	148	A176-HW15		
16(400)	A176-HW6	159	A176-HW16		
18(450)	A176-HW7	170	A176-HW17		
20(500)	A176-HW8	190	A176-HW18		
22(550)	A176-HW9	220	A176-HW19		
24(600)	A176-HW10	250	A176-HW20		

PRODUCT GROUP : A

HARDWARE & ACCESSORIES









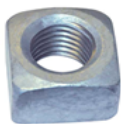

[A177] Angle Bolt แอ่งเกิลโบลท์

Code No.	Size (mm.)	Price (M-16)	Price (M-20)	Price (M-24)	Note
A177-HW01	130	60			
A177-HW02	150	65			
A177-HW03	170	70			
A177-HW04	200	75	90	95	
A177-HW05	250	80	95	130	
A177-HW06	300	85	100	150	
A177-HW07	350	90	110	210	
A177-HW08	400	95	120	230	
A177-HW09	450		140	300	
A177-HW10	500		160	350	
A177-HW11	550		180	400	
A177-HW12	600		200	450	

Underground Cable Rack & Support

Imag	Code No.	List	Price	Note
	A178-HW01	UG Cable support type C	สอบถาม	
	A178-HW02	UG Cable rack 14 hole	580	
	A178-HW03	UG Cable pulling iron พูลดิ่งไอซ์ออน	350	
	A178-HW04	Manhole step แมนโฮลสตีป	สอบถาม	
	A178-HW05	Ground wire support and clamp Type for bayonet	600	
	A178-HW06	Ground wire support and clamp Type for concrete pole	750	
	A178-HW07	Ground wire clam J-1152 ไอเจแคลมป์	40	
	A178-HW08	Guy clamp 1 bolt	70	
	A178-HW09	Guy clamp 2 bolt	85	
	A178-HW10	Guy clamp 3 bolt	150	
	A178-HW11	Cable sbacering	200	
	A178-HW12	Clamp single u-bolt M6(5/16")	สอบถาม	
	A178-HW13	Clamp single u-bolt M8(3/18")	18	
	A178-HW14	Clamp single u-bolt M12(1/2")	สอบถาม	
	A178-HW15	Clamp single u-bolt M16(5/8")	80	
	A178-HW16	Clamp double eye bolt M16(5/8")	สอบถาม	

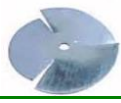
PRODUCT GROUP : A		HARDWARE & ACCESSORIES		
Image	Code No.	List	Price	Note
	A178-HW17	Hex. Nut นัทหกเหลี่ยม Size Hole 3/8 inch		
	A178-HW18	Hex. Nut นัทหกเหลี่ยม Size Hole 1/2 inch	13	
	A178-HW19	Hex. Nut นัทหกเหลี่ยม Size Hole 5/8 inch	15	
	A178-HW20	Hex. Nut นัทหกเหลี่ยม Size Hole 3/4 inch	23	
	A178-HW21	Hex. Nut นัทหกเหลี่ยม Size Hole 1 inch	38	
	A178-HW22	Square Nut นัทสี่เหลี่ยม Size Hole 3/8 inch		
	A178-HW23	Square Nut นัทสี่เหลี่ยม Size Hole 1/2 inch	13	
	A178-HW24	Square Nut นัทสี่เหลี่ยม Size Hole 5/8 inch	15	
	A178-HW25	Square Nut นัทสี่เหลี่ยม Size Hole 3/4 inch	23	
	A178-HW26	Square Nut นัทสี่เหลี่ยม Size Hole 1 inch	38	
	A178-HW27	Square Washer แหวนสี่เหลี่ยม Size Hole 3/8 inch		
	A178-HW28	Square Washer แหวนสี่เหลี่ยม Size Hole 1/2 inch	10	
	A178-HW29	Square Washer แหวนสี่เหลี่ยม Size Hole 5/8 inch	10	
	A178-HW30	Square Washer แหวนสี่เหลี่ยม Size Hole 3/4 inch	18	
	A178-HW31	Square Washer แหวนสี่เหลี่ยม Size Hole 1 inch	30	
	A178-HW32	Curve แหวนสี่เหลี่ยม Size Hole 1/2 inch	12	
	A178-HW33	Curve แหวนสี่เหลี่ยม Size Hole 5/8 inch	12	
	A178-HW34	Curve แหวนสี่เหลี่ยม Size Hole 3/4 inch	20	
	A178-HW35	Curve แหวนสี่เหลี่ยม Size Hole 1 inch	35	
	A178-HW36	Lock Washer แหวนสปริง Size Hole 3/8 inch		
	A178-HW37	Lock Washer แหวนสปริง Size Hole 1/2 inch	12	
	A178-HW38	Lock Washer แหวนสปริง Size Hole 5/8 inch	12	
	A178-HW39	Lock Washer แหวนสปริง Size Hole 3/8 inch	20	
	A178-HW40	Lock Washer แหวนสปริง Size Hole 1 inch	35	
	A178-HW41	Mounting Bracket for Cutout & Lightning Arrester ขาจับคัทเข้าท์และล่อฟ้า Cross Arm	400	
	A178-HW42	Mounting Bracket for Termination ขาจับเทอมิเนชั่น Cross Arm	500	
	A178-HW43	Pin for Insulator(ก้านลูกถ้วย)for Use with 24kV	สอบถาม	
	A178-HW44	Pin for Insulator(ก้านลูกถ้วย)for Use with 33kV	สอบถาม	
	A178-HW45	Pin for Insulator(ก้านลูกถ้วย)for Use with 33kV.Fog Type	สอบถาม	
	A178-HW46	Flat Brace for Crossarm(เหล็กประกบกับไม้คอน) Size 1¼"x1¼"x32"	95	
	A178-HW47	Flat Brace for Crossarm(เหล็กประกบกับไม้คอน) Size 1¼"x1¼"x36"	110	
	A178-HW48	Flat Brace for Crossarm(เหล็กประกบกับไม้คอน)Size30x6x760 mm.	90	
	A178-HW49	Flat Brace for Crossarm(เหล็กประกบกับไม้คอน)Size40x6x1000mm.	150	
	A178-HW50	Anchor Plate (จานสมอบก) Size 8 inch	240	
	A178-HW51	Anchor Plate (จานสมอบก) Size 10 inch	300	
	A178-HW52	Anchor Plate (จานสมอบก) Size 12 inch	400	

PRODUCT GROUP : A		HARDWARE & ACCESSORIES		
Image	Code No.	List	Price	Note
	A178-HW53	Heavy Type Racks Size Rack 1 Spool Thick 4mm.	สอบถาม	
	A178-HW54	Heavy Type Racks Size Rack 2 Spool Thick 4mm.		
	A178-HW55	Heavy Type Racks Size Rack 3 Spool Thick 4mm.		
	A178-HW56	Heavy Type Racks Size Rack 4 Spool Thick 4mm.		
	A178-HW57	Heavy Type Racks Size Rack 1 Spool Thick 5mm.	65	
	A178-HW58	Heavy Type Racks Size Rack 2 Spool Thick 5mm.	185	
	A178-HW59	Heavy Type Racks Size Rack 3 Spool Thick 5mm.	280	
	A178-HW60	Heavy Type Racks Size Rack 4 Spool Thick 5mm.	380	
	A178-HW61	Anchor Shackle Description M16	สอบถาม	
	A178-HW62	Twisted Bow Shackle Description M120	สอบถาม	
	A178-HW63	Clevis Eye Description Type B	สอบถาม	
	A178-HW64	Ball Clevis Description Type B	สอบถาม	
	A178-HW65	Ball Clevis Description Type K	สอบถาม	
	A178-HW66	Socket Eye Description 35-240 mm ²	สอบถาม	
	A178-HW67	Socket Eye Description 240-400 mm ²	สอบถาม	
	A178-HW68	Socket Eye Description 400-625 mm ²	สอบถาม	
	A178-HW69	Ball Y-Clevis Description Type J	สอบถาม	
	A178-HW70	Ball Hook Description Type B	สอบถาม	
	A178-HW71	Ball Eye Description Type B	สอบถาม	
	A178-HW72	Socket Clevis Description Type B	สอบถาม	
	A178-HW73	Socket Clevis Description Type K	สอบถาม	
	A178-HW74	Twisted Bow Socket Description Type J	สอบถาม	

PRODUCT GROUP : A

HARDWARE & ACCESSORIES

SUBSTATION FITTINGS

Image	Code No.	List	Price	Note
	A178-HW74	90 DEGREE TERMINAL STUD 40MM. TO 400 SQMM.	สอบถาม	
	A178-HW75	ALUMINIUM TERMINALS	สอบถาม	
	A178-HW76	ALUMINIUM TEE FOR CABLE AND TUBE	สอบถาม	
	A178-HW77	SUB BASE	สอบถาม	
	A178-HW78	ALUMINIUM BUS SUPPORT	สอบถาม	
	A178-HW79	ALUMINIUM WELDMENT TERMINAL	สอบถาม	



[A179] Fuse cutout ตรอปเอ๊าท์ฟิวส์แรงสูง

Code No.	Rated kV	Rated Amps	Rated kA	Price	Note
A179-HV01	27	100	8	4000	
A179-HV02	27	200	12	4500	
A179-HV03	27/35	100	8	6500	
A179-HV04	27/35	200	12	6000	



[A180] HV.Lighting Arresters ล้อฟ้าแรงสูง

Code No.	Rated kV	Rated kA	Price	Note
A180-HV01	9/10	5	2600	
A180-HV02	21	5	3800	
A180-HV03	24	5	5200	
A180-HV04	30	5	5500	
A180-HV05	21	10	6500	
A180-HV06	24	10	8500	
A180-HV07	30	10	10500	

PRODUCT GROUP : A

HIGHT VOLTAGE FUSE CUTOUT



[A181] Disconnect Switch **ดิสคอนเน็คติงสวิทช์แรงสูง**

Code No.	Rated kV	Rated Amps	Price	Note
A181-HV01	25.8	600	11000	
A181-HV02	38	600	25000	



[A182] Fuse Links Type K **ฟิวส์ลิงค์แรงสูง**

Code. No	Rated kV	Rated Amps	Price
A182-HV01	27	1	110
A182-HV02	27	2	
A182-HV03	27	3	
A182-HV04	27	6	
A182-HV05	27	8	120
A182-HV06	27	10	
A182-HV07	27	15	
A182-HV08	27	20	130
A182-HV09	27	25	
A182-HV10	27	30	160
A182-HV11	27	40	
A182-HV12	27	50	
A182-HV13	27	65	250
A182-HV14	27	100	
A182-HV15	27	140	650
A182-HV16	27	200	1100

Code. No	Rated kV	Rated Amps	Price
A182-HV17	35	1	140
A182-HV18	35	2	
A182-HV19	35	3	
A182-HV20	35	6	160
A182-HV21	35	8	
A182-HV22	35	10	
A182-HV23	35	15	180
A182-HV24	35	20	
A182-HV25	35	25	
A182-HV26	35	30	240
A182-HV27	35	40	
A182-HV28	35	50	
A182-HV29	35	65	600
A182-HV30	35	100	
A182-HV31	35	140	850
A182-HV32	35	200	1200

PRODUCT GROUP : A

HIGHT VOLTAGE FUSE CUTOUT



[A183] LV.Lighting Arrester

Code No.	Rated kV	Rated kA	Price	Note
A183-HV01	0.5	5	600	



[A184] LT Switch แอล ที สวิทช์

Code No.	Rated kV	Rated Amps	Price	Note
A184-HV01	25.8	600	950	



[A185] H.R.C. Fuse Link ฟิวส์ไบเมต

Code No.	Rated Amps	Price
A185-HV01	80	250
A185-HV02	100	
A185-HV03	160	
A185-HV04	200	
A185-HV05	250	350
A185-HV06	315	
A185-HV07	355	
A185-HV08	400	

PRODUCT GROUP : A

ACCESSORIES

[A186] ตะกร้อดึงสาย

Pulling Grips



Code No.	Model No.	Cable Range O.D.		Price
		Min	Max	
A186-GR01	TG 050-24	10 3/8"	12 1/2"	1100
A186-GR02	TG 062-24	12 1/2"	19 3/4"	1400
A186-GR03	TG 075-24	19 3/4"	25 1"	1800
A186-GR04	TG 100-24	25 1"	38 1 1/2"	2150
A186-GR05	TG 150-24	38 1 1/2"	50 2"	2700
A186-GR06	TG 200-24	50 2"	64 2 1/2"	3000
A186-GR07	TG 250-24	64 2 1/2"	76 3"	4200
A186-GR08	TG 300-24	76 3"	89 3 1/2"	4800
A186-GR09	TG 350-24	89 3 1/2"	102 4"	5400

[A186] Slack Grips



Code No.	Model No.	Cable Range O.D.		Price
		Min	Max	
A186-GR10	SG 075 A	19 3/4"	25 1"	2100
A186-GR11	SG 100 A	25 1"	32 1 1/4"	2450
A186-GR12	SG 125 A	32 1 1/4"	38 1 1/2"	2800
A186-GR13	SG 150 A	38 1 1/2"	44 1 3/4"	3200
A186-GR14	SG 175 A	44 1 3/4"	50 2"	3600
A186-GR15	SG 200 A	50 2"	64 2 1/2"	4000
A186-GR16	SG 250 A	64 2 1/2"	76 3"	4200
A186-GR17	SG 300 A	76 3"	89 3 1/2"	4500
A186-GR18	SG 350 A	89 3 1/2"	102 4"	4800

PRODUCT GROUP : A

ACCESSORIES

[A187] ตะกร้อหัวสาย Support Grips



Type SU (Single Eye)

Code No.	Model No.	Cable Range O.D.		Breaking In. lbs.	Price
		Min	Max		
A187-GR01	SPC 050 SU	1/2"	5/8"	600	1200
A187-GR02	SPC 075 SU	5/8"	3/4"	1200	1500
A187-GR03	SPC 100 SU	1"	1*1/4	1500	1700
A187-GR04	SPC 150SU	1*1/2	1*3/4	2000	2100
A187-GR05	SPC 175 SU	1*3/4	2"	2450	2600
A187-GR06	SPC 200 SU	2"	2*1/2	3260	3100
A187-GR07	SPC 250 SU	2*1/2	3"	3260	3600
A187-GR08	SPC 300 SU	3"	3*1/2	5600	5500
A187-GR09	SPC 350 SU	3*1/2	4"	5600	5900

Type SDE (Double Eye)

Code No.	Model No.	Cable Range O.D.		Breaking In. lbs.	Price
		Min	Max		
A187-GR10	SPC 050 SDE	1/2"	5/8"	600	1200
A187-GR11	SPC 075 SDE	5/8"	3/4"	1200	1500
A187-GR12	SPC 100 SDE	1"	1*1/4	1500	1700
A187-GR13	SPC 150 SDE	1*1/2	1*3/4	2000	2100
A187-GR14	SPC 175 SDE	1*3/4	2"	2450	2600
A187-GR15	SPC 200 SDE	2"	2*1/2	3260	3100
A187-GR16	SPC 250 SDE	2*1/2	3"	3260	3600
A187-GR17	SPC 300 SDE	3"	3*1/2	5600	5500
A187-GR18	SPC 350 SDE	3*1/2	4"	5600	5900

PRODUCT GROUP : A

ACCESSORIES

[A188] ตะกร้อหัวสาย Support Grips



Type SSO (Single Eye)

Code No.	Model No.	Cable Range O.D.		Breaking In. lbs.	Price
		Min	Max		
A188-GR01	SPC 075 SSO	5/8"	3/4"	1100	1800
A188-GR02	SPC 100 SSO	1"	1*1/4	1400	2000
A188-GR03	SPC 150 SSO	1*1/2	1*3/4	1800	2400
A188-GR04	SPC 175 SSO	1*3/4	2"	2150	2700
A188-GR05	SPC 200 SSO	2"	2*1/2	3260	3100
A188-GR06	SPC 250 SSO	2*1/2	3"	3260	3800
A188-GR07	SPC 300 SSO	3"	3*1/2	5600	5800
A188-GR08	SPC 350 SSO	3*1/2	4"	5600	6200

Type SDE (Double Eye)

Code No.	Model No.	Cable Range O.D.		Breaking In. lbs.	Price
		Min	Max		
A188-GR09	SPC 075 SDE	5/8"	3/4"	1100	1800
A188-GR10	SPC 100 SDE	1"	1*1/4	1400	2000
A188-GR11	SPC 150 SDE	1*1/2	1*3/4	1800	2400
A188-GR12	SPC 175 SDE	1*3/4	2"	2150	2700
A188-GR13	SPC 200 SDE	2"	2*1/2	3260	3100
A188-GR14	SPC 250 SDE	2*1/2	3"	3260	3800
A188-GR15	SPC 300 SDE	3"	3*1/2	5600	5800
A188-GR16	SPC 350 SDE	3*1/2	4"	5600	6200

PRODUCT GROUP : A

ACCESSORIES

[A189] Tape



Tape PVC เทป พีวีซี

Code No.	List	Price
A189-TP01	Small	25
A189-TP02	Large	100



Code No.	List	Price
A189-TP03	Tape 3M#23 เทปแรงสูง	380



Code No.	List	Price
A189-TP04	Tape 3M#33 เทปแรงต่ำ	200



Code No.	List	Price
A189-TP05	Tape #2517 เทปละลาย	350



Code No.	List	Price
A189-TP06	Tape #2705 เทปละลาย	180

PRODUCT GROUP : A

CONDUIT

[A190-192] Conduitt



PAT

Size	E.M.T.		I.M.C.		R.S.C.	
	Code	Price	Code	Price	Code	Price
1/2"	A190-CO01	133	A190-CO07	282	A190-CO17	374
3/4"	A190-CO02	192	A190-CO08	375	A190-CO18	478
1"	A190-CO03	273	A190-CO09	506	A190-CO19	702
1" 1/4	A190-CO04	476	A190-CO10	653	A190-CO20	906
1" 1/2	A190-CO05	555	A190-CO11	802	A190-CO21	1080
2"	A190-CO06	688	A190-CO12	1096	A190-CO22	1446
2" 1/2			A190-CO13	1714	A190-CO23	2151
3"			A190-CO14	2122	A190-CO24	2764
3" 1/2			A190-CO15	2440	A190-CO25	3625
4"			A190-CO16	2802	A190-CO26	4073
5"					A190-CO27	5858
6"					A190-CO28	7010



Panasonic

Size	E.M.T.		I.M.C.		R.S.C.	
	Code	Price	Code	Price	Code	Price
1/2"	A191-CO01	133	A191-CO07	282	A191-CO17	342
3/4"	A191-CO02	192	A191-CO08	375	A191-CO18	436
1"	A191-CO03	273	A191-CO09	506	A191-CO19	641
1" 1/4	A191-CO04	476	A191-CO10	653	A191-CO20	828
1" 1/2	A191-CO05	555	A191-CO11	802	A191-CO21	985
2"	A191-CO06	688	A191-CO12	1096	A191-CO22	1317
2" 1/2			A191-CO13	1714	A191-CO23	
3"			A191-CO14	2122	A191-CO24	
3" 1/2			A191-CO15	2440	A191-CO25	
4"			A191-CO16	2802	A191-CO26	
5"					A191-CO27	
6"					A191-CO28	

PRODUCT GROUP : A

CONDUIT

[A190-192] Conduit



RSI

Size	E.M.T.		I.M.C.		R.S.C.	
	Code	Price	Code	Price	Code	Price
1/2"	A192-CO01	116	A192-CO07	246	A192-CO17	332
3/4"	A192-CO02	165	A192-CO08	331	A192-CO18	424
1"	A192-CO03	237	A192-CO09	447	A192-CO19	623
1" 1/4	A192-CO04	407	A192-CO10	575	A192-CO20	809
1" 1/2	A192-CO05	475	A192-CO11	705	A192-CO21	959
2"	A192-CO06	590	A192-CO12	971	A192-CO22	1285
2" 1/2			A192-CO13	1514	A192-CO23	2133
3"			A192-CO14	1878	A192-CO24	2749
3" 1/2			A192-CO15	2365	A192-CO25	3211
4"			A192-CO16	1445	A192-CO26	4048
5"					A192-CO27	5829
6"					A192-CO28	7017

[A193-194] Conduit



List	E.M.T. ELBOW ท่อโค้งบาง		I.M.C. ELBOW ท่อโค้งหนา	
Size	E.M.T.		I.M.C.	
	Code	Price	Code	Price
1/2"	A193-CO01	17	A194-CO01	28
3/4"	A193-CO02	23	A194-CO02	34
1"	A193-CO03	34	A194-CO03	51
1" 1/4	A193-CO04	51	A194-CO04	68
1" 1/2	A193-CO05	69	A194-CO05	100
2"	A193-CO06	90	A194-CO06	135
2" 1/2			A194-CO07	390
3"			A194-CO08	560
3" 1/2			A194-CO09	1050
4"			A194-CO10	1250
5"			A194-CO11	3600
6"			A194-CO12	4200

PRODUCT GROUP : A

WIREWAY&FITTING

[A195] Wireway รางไวร์เวย์



Code NO.	Size	Price/EA.			
		0.7	1	1.2	1.5
A195-WW01	2"x3"x4'	230	300	350	415
A195-WW02	2"x4"x4'	265	350	410	490
A195-WW03	3"x4"x4'	305	405	470	560
A195-WW04	4"x4"x4'	340	455	530	640
A195-WW05	4"x6"x4'	420	555	650	790
A195-WW06	4"x8"x4'	495	655	765	920
A195-WW07	4"x10"x4'		765	890	1060
A195-WW08	4"x12"x4'		865	1000	1205
A195-WW09	2"x3"x8'	435	580	670	800
A195-WW10	2"x4"x8'	510	680	790	950
A195-WW11	3"x4"x8'	585	780	905	1100
A195-WW12	4"x4"x8'	655	880	1030	1250
A195-WW13	4"x6"x8'	805	1080	1260	1520
A195-WW14	4"x8"x8'	950	1280	1490	1790
A195-WW15	4"x10"x8'		1480	1720	2070
A195-WW16	4"x12"x8'		1690	1950	2350
A195-WW17	6"x8"x8'		1480	1820	2080
A195-WW18	6"x10"x8'		1680	2010	2360
A195-WW19	6"x12"x8'		1880	2180	2640

[A196] ELBOW,INSIDE RISER,OUTSIDE RISER ข้องอ90 เปิดบน,เปิดใน,เปิดนอก



Code NO.	Size	Price/EA.		
		1	1.2	1.5
A196-WW01	2"x3'	225	265	305
A196-WW02	2"x4"	255	300	350
A196-WW03	3"x4"	285	335	395
A196-WW04	4"x4"	315	370	440
A196-WW05	4"x6"	360	440	520
A196-WW06	4"x8"	420	510	600
A196-WW07	4"x10"	480	580	680
A196-WW08	4"x12"	540	650	760
A196-WW09	6"x8"	480	580	680
A196-WW10	6"x10"	580	650	760
A196-WW11	6"x12"	640	730	860

[A197] TEE WAY ข้อต่อสามทาง



Code NO.	Size	Price/EA.		
		1	1.2	1.5
A197-WW01	2"x3'	315	375	425
A197-WW02	2"x4"	350	415	495
A197-WW03	3"x4"	385	455	656
A197-WW04	4"x4"	420	495	635
A197-WW05	4"x6"	490	575	725
A197-WW06	4"x8"	560	685	815
A197-WW07	4"x10"	620	765	905
A197-WW08	4"x12"	680	845	995
A197-WW09	6"x8"	620	765	905
A197-WW10	6"x10"	680	845	995
A197-WW11	6"x12"	750	925	1085

[A198] VERTICAL TEE ข้อต่อสามทางลงล่าง

Code NO.	Size	Price/EA.		
		1	1.2	1.5
A198-WW01	2"x3'	380	450	550
A198-WW02	2"x4"	420	500	600
A198-WW03	3"x4"	460	550	650
A198-WW04	4"x4"	500	600	700
A198-WW05	4"x6"	580	700	800
A198-WW06	4"x8"	660	800	900
A198-WW07	4"x10"	740	900	1000
A198-WW08	4"x12"	820	1000	1100
A198-WW09	6"x8"	740	900	1000
A198-WW10	6"x10"	820	1000	1100
A198-WW11	6"x12"	900	1100	1200

[A199] CROSS ข้อต่อสี่ทาง

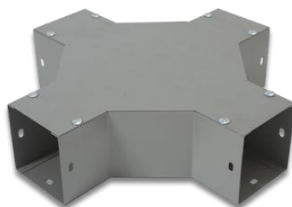

Code NO.	Size	Price/EA.		
		1	1.2	1.5
A199-WW01	2"x3'	450	550	625
A199-WW02	2"x4"	500	620	700
A199-WW03	3"x4"	550	690	775
A199-WW04	4"x4"	600	760	850
A199-WW05	4"x6"	700	840	1000
A199-WW06	4"x8"	800	960	1150
A199-WW07	4"x10"	900	1080	1250
A199-WW08	4"x12"	1000	1200	1400
A199-WW09	6"x8"	900	1080	1250
A199-WW10	6"x10"	1000	1200	1400
A199-WW11	6"x12"	1100	1320	1550

PRODUCT GROUP : A

CABLE LADDER&FITTING

[A200] CABLE LADDER แลคเตอร์



Code No.	Size mm.	Price/EA.
A200-CL01	200x100x3000	1200
A200-CL02	300x100x3000	1425
A200-CL03	400x100x3000	1650
A200-CL04	500x100x3000	1920
A200-CL05	600x100x3000	2175
A200-CL06	700x100x3000	2400
A200-CL07	800x100x3000	2625
A200-CL08	900x100x3000	2820
A200-CL09	1000x100x3000	3000

[A201] HORIZONTAL ELBOW งอฉากแลคเตอร์

Code No.	Size mm.	Price/EA.
A201-CL01	200x100	400
A201-CL02	300x100	475
A201-CL03	400x100	550
A201-CL04	500x100	640
A201-CL05	600x100	725
A201-CL06	700x100	800
A201-CL07	800x100	875
A201-CL08	900x100	940
A201-CL09	1000x100	1000



[A202] INSIDE VETICAL RISER งอขึ้นแลคเตอร์

Code No.	Size mm.	Price/EA.
A202-CL01	200x100	500
A202-CL02	300x100	575
A202-CL03	400x100	665
A202-CL04	500x100	740
A202-CL05	600x100	800
A202-CL06	700x100	875
A202-CL07	800x100	965
A202-CL08	900x100	1050
A202-CL09	1000x100	1140



[A203] OUTSIDE VETICAL RISER งอลงแลคเตอร์

Code No.	Size mm.	Price/EA.
A203-CL01	200x100	500
A203-CL02	300x100	575
A203-CL03	400x100	665
A203-CL04	500x100	740
A203-CL05	600x100	800
A203-CL06	700x100	875
A203-CL07	800x100	965
A203-CL08	900x100	1050
A203-CL09	1000x100	1140



PRODUCT GROUP : A

CABLE LADDER&FITTING

[A204] HORIZONTAL TEE สามทางแลคเตอร์



Code No.	Size mm.	Price/EA.
A204-CL01	200x100	600
A204-CL02	300x100	715
A204-CL03	400x100	825
A204-CL04	500x100	950
A204-CL05	600x100	1075
A204-CL06	700x100	1215
A204-CL07	800x100	1325
A204-CL08	900x100	1440
A204-CL09	1000x100	1550

[A205] HORIZONTAL CROSS สี่ทางแลคเตอร์

Code No.	Size mm.	Price/EA.
A205-CL01	200x100	800
A205-CL02	300x100	950
A205-CL03	400x100	1090
A205-CL04	500x100	1040
A205-CL05	600x100	1240
A205-CL06	700x100	1370
A205-CL07	800x100	1515
A205-CL08	900x100	1650
A205-CL09	1000x100	1790



[A206] LADDER FITTING อุปกรณ์แลคเตอร์

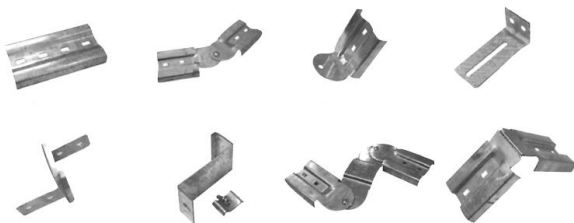

Code No.	Type	Price/EA.
A206-CL01	ข้อต่อปรับขึ้น-ลง	140
A206-CL02	ข้อยึดเพดาน	30
A206-CL03	ข้อต่อตรง	60
A206-CL04	ข้อลดความกว้าง	60
A206-CL05	ข้อต่อลงตู้	75
A206-CL06	ข้อโยกค้อม้า	250
A206-CL07	ข้อยึด	120

PRODUCT GROUP : A

CABLE TRAY&FITTING

[A207] CABLE TRAT เคเบิลเทรย์

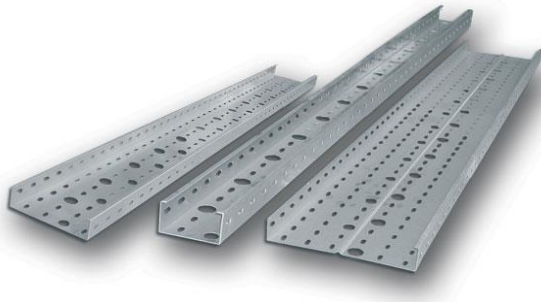

Code No.	Size mm.	Price/EA.
A207-CT01	200x100x2400	732
A207-CT02	300x100x2400	960
A207-CT03	400x100x2400	1200
A207-CT04	500x100x2400	1440
A207-CT05	600x100x2400	1680
A207-CT06	700x100x2400	2076
A207-CT07	800x100x2400	2556
A207-CT08	900x100x2400	2820
A207-CT09	1000x100x2400	3156

[A208] HORIZONTAL ELBOW งอฉากเคเบิลเทรย์

Code No.	Size mm.	Price/EA.
A208-CT01	200x100	440
A208-CT02	300x100	585
A208-CT03	400x100	690
A208-CT04	500x100	815
A208-CT05	600x100	940
A208-CT06	700x100	1065
A208-CT07	800x100	1190
A208-CT08	900x100	1315
A208-CT09	1000x100	1440

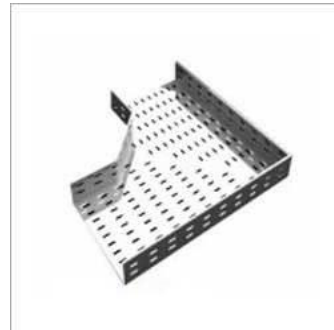

[A209] INSIDE VETICAL RISER งอขึ้นเคเบิลเทรย์

Code No.	Size mm.	Price/EA.
A209-CT01	200x100	375
A209-CT02	300x100	440
A209-CT03	400x100	500
A209-CT04	500x100	565
A209-CT05	600x100	625
A209-CT06	700x100	690
A209-CT07	800x100	750
A209-CT08	900x100	815
A209-CT09	1000x100	875



[A210] OUTSIDE VETICAL RISER งอลงเคเบิลเทรย์

Code No.	Size mm.	Price/EA.
A210-CT01	200x100	375
A210-CT02	300x100	440
A210-CT03	400x100	500
A210-CT04	500x100	565
A210-CT05	600x100	625
A210-CT06	700x100	690
A210-CT07	800x100	750
A210-CT08	900x100	815
A210-CT09	1000x100	875

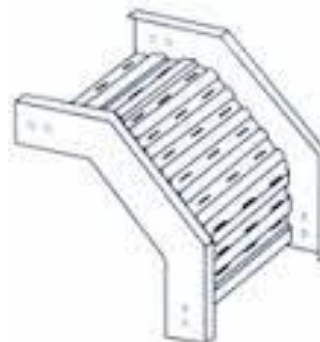

PRODUCT GROUP : A

CABLE TRAY&FITTING



[A211] HORIZONTAL TEE สามทางเคเบิลเทรย์

Code No.	Size mm.	Price/EA.
A211-CT01	200x100	565
A211-CT02	300x100	690
A211-CT03	400x100	815
A211-CT04	500x100	940
A211-CT05	600x100	1065
A211-CT06	700x100	1190
A211-CT07	800x100	1315
A211-CT08	900x100	1440
A211-CT09	1000x100	1565

[A212] HORIZONTAL CROSS สี่ทางเคเบิลเทรย์

Code No.	Size mm.	Price/EA.
A212-CT01	200x100	690
A212-CT02	300x100	815
A212-CT03	400x100	940
A212-CT04	500x100	1065
A212-CT05	600x100	1190
A212-CT06	700x100	1315
A212-CT07	800x100	1440
A212-CT08	900x100	1565
A212-CT09	1000x100	1690



[A213] LADDER TRAY FITTING อุปกรณ์เคเบิลเทรย์



Code No.	Type	Price/EA.
A213-CT01	ข้อต่อปรับขึ้น-ลง	140
A213-CT02	ข้อยึดเพดาน	30
A213-CT03	ข้อต่อตรง	60
A213-CT04	ข้อลดความกว้าง	60
A213-CT05	ข้อต่อลงตู้	75
A213-CT06	ข้อโยกคอกม้า	250
A213-CT07	ข้อยึด	120

[A214] Termination Kit หัวสาย

Three Core Termination

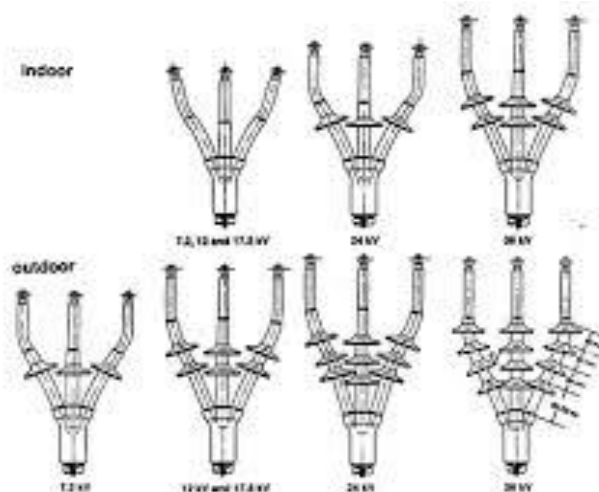

kV	Sqmm.	Tree Core Type (1 Three Core / Box)			
		Indoor	Price List	Outdoor	Price List
3.3 Unscreened Cable	16-50	A214-TK01	5300	A214-TK21	12200
	70-120	A214-TK02	5750	A214-TK22	12600
	150-240	A214-TK03	6300	A214-TK23	13700
	300-500	A214-TK04	8150	A214-TK24	15200
3.3-7.2 Screened (Shield) Cable	16-50	A214-TK05	5450	A214-TK25	11400
	70-120	A214-TK06	5850	A214-TK26	11800
	150-240	A214-TK07	6800	A214-TK27	13650
	300-500	A214-TK08	8200	A214-TK28	15700
12-17.5	16-35	A214-TK09	6800	A214-TK29	15200
	50-70	A214-TK10	7400	A214-TK30	16000
	95-240	A214-TK11	8600	A214-TK31	18300
	240-400	A214-TK12	9700	A214-TK32	21000
24	25-35	A214-TK13	8050	A214-TK33	23000
	50-70	A214-TK14	10200	A214-TK34	24000
	95-185	A214-TK15	11800	A214-TK35	28000
	240-400	A214-TK16	14000	A214-TK36	33000
36	35-50	A214-TK17	14700	A214-TK37	30500
	70-120	A214-TK18	17900	A214-TK38	36000
	150-185	A214-TK19	19800	A214-TK39	38300
	240-500	A214-TK20	21700	A214-TK40	42000

[A215] MDB Main Distribution Board



Code No.	กว้าง	สูง	ลึก	น้ำหนัก	Price List
	W/mm.	H/mm.	D/mm.	Weight/Kgs.	
A215-MDB01	600	1800	400	118	สอบถาม
A215-MDB02	600	1800	600	134	สอบถาม
A215-MDB03	800	1800	600	155	สอบถาม
A215-MDB04	800	2100	600	172	สอบถาม
A215-MDB05	800	2100	800	191	สอบถาม
A215-MDB06	1000	2100	600	196	สอบถาม
A215-MDB07	1000	2100	800	215	สอบถาม
A215-MDB08	1000	2100	1000	234	สอบถาม

Code NO.	กว้าง	กว้าง 1	กว้าง 2	สูง	ลึก	น้ำหนัก	Price List.
	W/mm.	W/mm. 1	W/mm. 2	H/mm.	D/mm.	Weight/Kgs.	
A215-MDB09	1200	600	600	1800	400	212	สอบถาม
A215-MDB10	1200	600	600	1800	600	234	สอบถาม
A215-MDB11	1600	800	800	1800	600	276	สอบถาม
A215-MDB12	1600	800	800	2100	600	307	สอบถาม
A215-MDB13	1600	800	800	2100	800	333	สอบถาม
A215-MDB14	2000	1000	1000	2100	600	334	สอบถาม
A215-MDB15	2000	1000	1000	2100	800	360	สอบถาม
A215-MDB16	2000	1000	1000	2100	1000	387	สอบถาม

Code No.	กว้าง	กว้าง 1	กว้าง 2	กว้าง 3	สูง	ลึก	น้ำหนัก	Price List.
	W/mm.	W/mm. 1	W/mm. 2	W/mm 3	H/mm.	D/mm.	Weight/Kgs.	
A215-MDB17	1800	600	600	600	1800	400	306	สอบถาม
A215-MDB18	1800	600	600	600	1800	600	334	สอบถาม
A215-MDB19	2400	800	800	800	1800	600	397	สอบถาม
A215-MDB20	2400	800	800	800	2100	600	441	สอบถาม
A215-MDB21	2400	800	800	800	2100	800	474	สอบถาม
A215-MDB22	3000	1000	1000	1000	2100	600	450	สอบถาม
A215-MDB23	3000	1000	1000	1000	2100	800	485	สอบถาม
A215-MDB24	3000	1000	1000	1000	2100	1000	520	สอบถาม

[A216] HDPEHDPE & CONDUIT FITTINGS

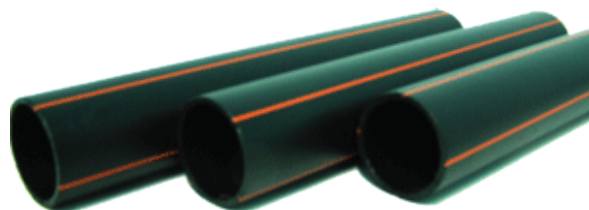

SIZE		PRICE		
DESIGNATION OD.		CONDUIT CLASS		
นิ้ว	มิลลิเมตร	PN 6	PN 6.3	PN 10
1/2"	20	13	-	-
3/4"	25	16	-	22
1"	32	24	-	33
1-1/4"	40	34	35	52
1-1/2"	50	53	53	80
2"	63	83	78	119
2-1/2"	75	116	112	168
3"	90	166	152	227
4"	110	248	228	337
-	125	318	291	434
5"	140	399	365	544
6"	160	520	478	709
-	180	655	601	900
8"	200	810	744	1104



PRICE				
SIZE (OD)	COUPLING TYPE A	COUPLING TYPE B	BELL MOUTH (End Bell)	ELBOW
20	22	25	-	-
25	24	27	38	96
32	28	32	45	108
40	35	40	54	120
50	45	50	65	165
63	53	58	77	215
75	76	83	104	312
90	103	113	141	579
110	142	149	186	898
125	162	170	231	1152
140	244	256	320	1433
160	263	276	345	1860
180	400	400	518	3490
200	505	520	650	5730

[A217] TRANSFORMER



PRICE

Code No.	Size	Price/EA.
A217-TFM01	หม้อแปลง 30 เควีเอ 1 เฟส 22-0.4/0.23 เควี	สอบถาม
A217-TFM02	หม้อแปลง 50 เควีเอ 3 เฟส แบบถังปิดฉนวนถาวร 22-0.4/0.23 เควี ตีวายเอ็น 11	สอบถาม
A217-TFM03	หม้อแปลง 100 เควีเอ 3 เฟส แบบถังปิดฉนวนถาวร 22-0.4/0.23 เควี ตีวายเอ็น 11	สอบถาม
A217-TFM04	หม้อแปลง 160 เควีเอ 3 เฟส แบบถังปิดฉนวนถาวร 22-0.4/0.23 เควี ตีวายเอ็น 11	สอบถาม
A217-TFM05	หม้อแปลง 250 เควีเอ 3 เฟส แบบถังปิดฉนวนถาวร 22-0.4/0.23 เควี ตีวายเอ็น 11	สอบถาม
A217-TFM06	หม้อแปลง 50 เควีเอ 3 เฟส แบบถังปิดฉนวนถาวร 33-0.4/0.23 เควี ตีวายเอ็น 11	สอบถาม
A217-TFM07	หม้อแปลง 100 เควีเอ 3 เฟส แบบถังปิดฉนวนถาวร 33-0.4/0.23 เควี ตีวายเอ็น 11	สอบถาม
A217-TFM08	หม้อแปลง 160 เควีเอ 3 เฟส แบบถังปิดฉนวนถาวร 33-0.4/0.23 เควี ตีวายเอ็น 11	สอบถาม
A217-TFM09	หม้อแปลง 250 เควีเอ 3 เฟส แบบถังปิดฉนวนถาวร 33-0.4/0.23 เควี ตีวายเอ็น 11	สอบถาม
A217-TFM10	หม้อแปลง 250 เควีเอ 3 เฟส แบบถังปิดฉนวนถาวร 33-0.4/0.23 เควี แบบแขวน	สอบถาม

PRODUCT GROUP : A

Low-Voltage

[A218] Main Breaker 2P 10kA



Pole(kA)	Rating	Code No.	Price
2P/10 kA	16 A	A218-LVT01	700
	20 A	A218-LVT02	
	25 A	A218-LVT03	
	32 A	A218-LVT04	
	40 A	A218-LVT05	
	50 A	A218-LVT06	1000
	63 A	A218-LVT07	

[A219] Molded Circuit Breaker

Fixed Type

Lcu(kA)	Rating	Code No.	Price
18 kA 380/415	16 A	A219-MCB01	2000
	20 A	A219-MCB02	
	25 A	A219-MCB03	
	40 A	A219-MCB04	
	50 A	A219-MCB05	
	63 A	A219-MCB06	
25 kA 380/415	16 A	A219-MCB07	2400
	20 A	A219-MCB08	
	25 A	A219-MCB09	
	40 A	A219-MCB10	
	50 A	A219-MCB11	
	63 A	A219-MCB12	



	Lcu(kA)	Rating	Code No.	Price
Adjusttable ปรับ Amp Tirp 0.8/0.9/0.1	30 kA 380/415	16 A	A219-MCB13	2500
		25 A	A219-MCB14	
		40 A	A219-MCB15	
		63 A	A219-MCB16	
		100 A	A219-MCB17	
	50 kA 380/415	16 A	A219-MCB18	2600
		25 A	A219-MCB19	
		40 A	A219-MCB20	
		63 A	A219-MCB21	
	30 kA 380/415	125 A	A219-MCB23	4000
		160 A	A219-MCB24	
		200 A	A219-MCB25	
		250A	A219-MCB26	
	50 kA 380/415	125 A	A219-MCB27	5000
		160 A	A219-MCB28	
		200 A	A219-MCB29	
	40 kA 380/415	250 A	A219-MCB31	9500
		400 A	A219-MCB32	
70 kA 380/415	250 A	A219-MCB33	9900	
	400 A	A219-MCB34		
40 kA 380/415	500 A	A219-MCB35	10,900	
	630 A	A219-MCB36		
70 kA 380/415	500 A	A219-MCB37	11,900	
	630 A	A219-MCB38		



PRODUCT GROUP : A

Low-Voltage

[A220] Circuit Breaker



Pole(kA)	Rating	Code No.	Price
1P/6 kA	1 A	A220-LCB01	300
	2 A	A220-LCB02	
	3 A	A220-LCB03	
	4 A	A220-LCB04	
	5 A	A220-LCB05	
	6 A	A220-LCB06	180
	10 A	A220-LCB07	
	16 A	A220-LCB08	
	20 A	A220-LCB09	
	25 A	A220-LCB10	
	32 A	A220-LCB11	300
	40 A	A220-LCB12	
	50 A	A220-LCB13	
	63 A	A220-LCB14	

[A221] ตู้คอนซูมเมอร์ ยูนิต แบบ Din-Rail

Way	Code No.	Price
6 ช่อง	A221-LVC01	1000
8 ช่อง	A221-LVC02	1120
12 ช่อง	A221-LVC03	1170
16 ช่อง	A221-LVC04	1190



[A222] Plug in Relay



Rate Current	LED	Code No.	Price
2 C/0 5A	มี LED(AC)	A222-LPR01	150
	NO(AC) Socket 8	A222-LPR02	140
	ขา	A222-LPR03	70
4 C/0 3A	มี LED(AC)	A222-LPR04	175
	NO(AC) Socket 14	A222-LPR05	160
	ขา	A222-LPR06	75

[A224] HRT 16 FUSE

Pole	(A)	Code No.	Price
Size 00	25A-100A	A224-LHF01	170
	125A-160A	A224-LHF02	190
Size 1	125A-250A	A224-LHF03	490
Size 2	300A-400A	A224-LHF04	740

[A223] HRT 18 FUSE

Pole(A)	Code No.	Price
1P 32A	A223-LVF01	95
2A ... 32A	A223-LVF02	15



[A225] Fuse Base



Pole	(A)	Code No.	Price
HRT16-00	160A	A225-LFB01	250
HRT16-1	250A	A225-LFB02	600
HRT16-2	400A	A225-LFB03	950

[A226]



STRAIN CLAMP 35-70 ACSR

[A227]



STRAIN CLAMP 70-185 ACSR

[A228]



STRAIN CLAMP 50-95 ACSR

[A229]



STRAIN CLAMP 95-150 ACSR

[A230]



STRAIN CLAMP 185-240 ACSR

[A231]

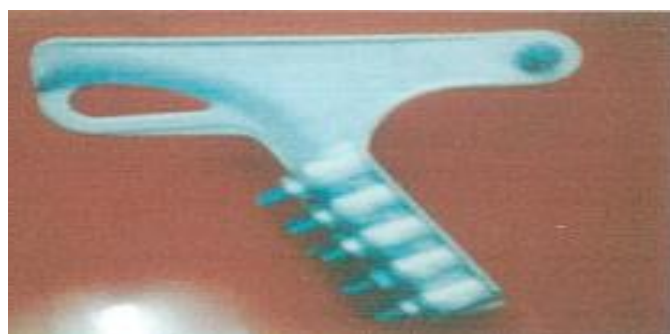

STRAIN CLAMP 240-400 ACSR

[A232]



A/L.Tee Plate 12 Holes

[A233]



Connectors For Stud 400 Sq.mm.

[A234]



Compression Dead End 400 Sq.mm.

[A235]



Full Tension 400 Sq.mm.

[A236]



Compression Tee 400 Sq.mm.

[A237]



Compression Dead End 400 Sq.mm.

PRODUCT GROUP : A

Low-Voltage

[A238]



Jumper Terminal 185 Sq.mm. 4 ५

[A239]



Jumper Terminal 240 Sq.mm.

SUBSTATION FITTINGS

[A240]



Tee Connectors 1 1/2" For 240 Sq.mm.

[A241]



Couper Tube To Tube 1 1/2" IPS

[A242]



V-Connectors For 1 1/2"

[A243]



Bus Support 5" For Tube 1 1/2"

[A244]



Bus Support 5" For Two Cable 400 Sq.mm.

[A245]



Bus Support 5" For Single Cable 400 Sq.mm.

[A246]



Bus Support 3" For Two Cable 400 Sq.mm.

[A247]



Bus Support 3" For Single Cable 400 Sq.mm.

SUBSTATION FITTINGS

[A248]



[A249]



[A250]



[A251]



[A252]

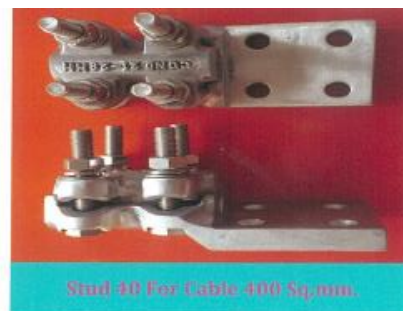

[A253]



SUBSTATION FITTINGS

[A254]



Stud 40 Nema Pad

[A255]



Stud 40 Nema Pad 90 Deg.

[A256]



Stud 40 Nema Pad 90 Deg.

[A257]



Aluminium Weldment Terminal Two Cable

[A258]



Aluminium Weldment Terminal 90 Deg.

[A259]



Terminal Tube 3" Nema Pad

[A260]



SIBBEST 5"

[A261]



Welding Angle 'T' Connector for Tube To Tube

SUBSTATION FITTINGS

[A262]



[A263]



[A264]



[A265]



[A266]



[A267]



[A268]



[A269]



SUBSTATION FITTINGS

[A270]



[A271]

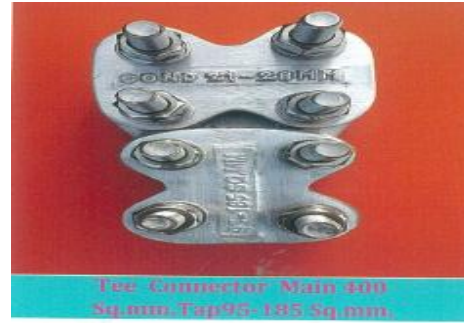

[A273]



[A274]



[A275]



[A276]



[A277]

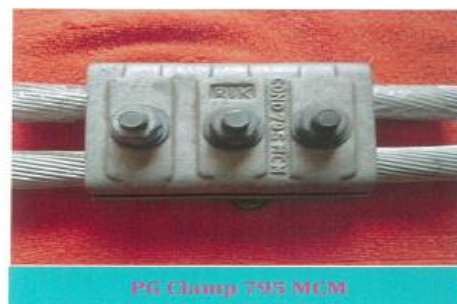

หมายเหตุ

สินค้าออกเหนือจากรายการข้างต้นในแคตตาล็อกแล้ว ทางบริษัท
 รับผิดชอบสินค้าตามแบบที่ลูกค้าต้องการได้



เครื่องมือ



รอกพาดสาย 115 KV 3 ร่อง

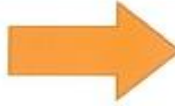

รอกพาดสาย 115 KV 2 ร่อง



รอกพาดสาย 115 KV 1 ร่อง



รอกพาดสายระบบ 22-33 KV 185 Sq.mm.



รอกส่งเต็รื่องมือ 3"



รอกลากสายใต้ดิน



เข็มขัดเซฟตี้ แบบครึ่งตัวตะขอเล็ก NP-737

- เข็มขัดคาดเอวตะขอเล็ก NP-737
- พร้อมเชือกนิรภัย 14 มม. ยาว 1.5 ม.
- เข็มขัดกว้าง 55 มม. ยาว 120 ซม. พร้อมตะขอเล็ก ระบบล็อก 2 ชั้น
- วัสดุผลิตจากโพลีเอทิลีน
- มาตรฐาน CE0321/EN 358



เข็มขัดนิรภัย ก้นตก รุ่น DHQS-101

- ชุดแบบเต็มตัว
- ชุดมี D-ring ด้านหน้า 1 จุด (ด้านหลัง 1 จุด, เอว 2 จุด)
- มี Support ที่เอว และ ที่ขา
- มาตรฐาน CE0321 / EN361 / EN813



ชุดกันตกจากที่สูง 1 D-Ring พร้อม 2 ตะขอคู่

- ผลิตจากสาย Polyester ขนาด 45 มม
- D Ring ทั้งหมด 1 จุด มาตรฐาน EN361
- รับแรงได้ 15 KN (1,530 KG)
- มาพร้อมตะขอคู่อย่างดี มาตรฐาน EN354