

Har820 STRAIGHT TOP CHAINS

TOP CHAINS 820
P=38.1mm, T=14.2mm
PIN:Stainless steel

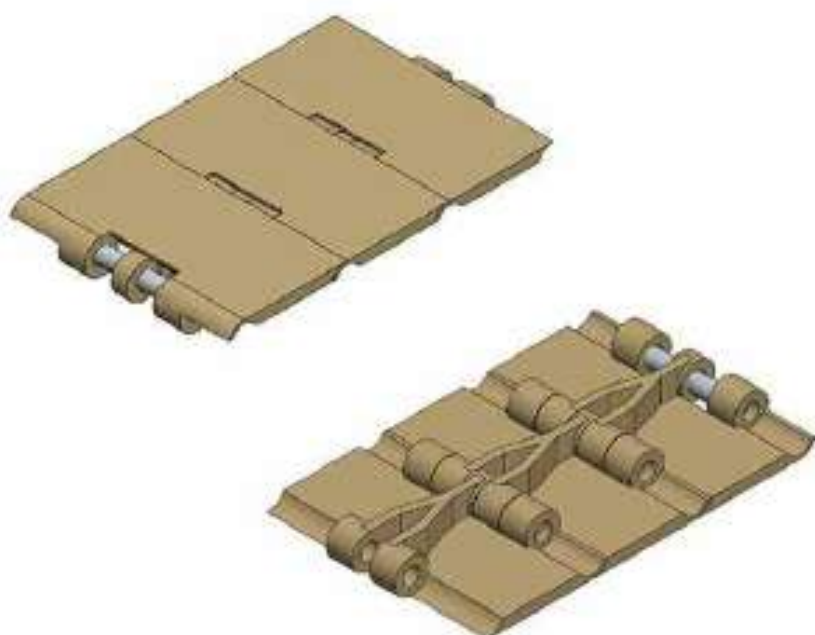

节距 Pitch	链板材质 Material	颜色 Color
38.1mm	POM	咖啡色/Brown

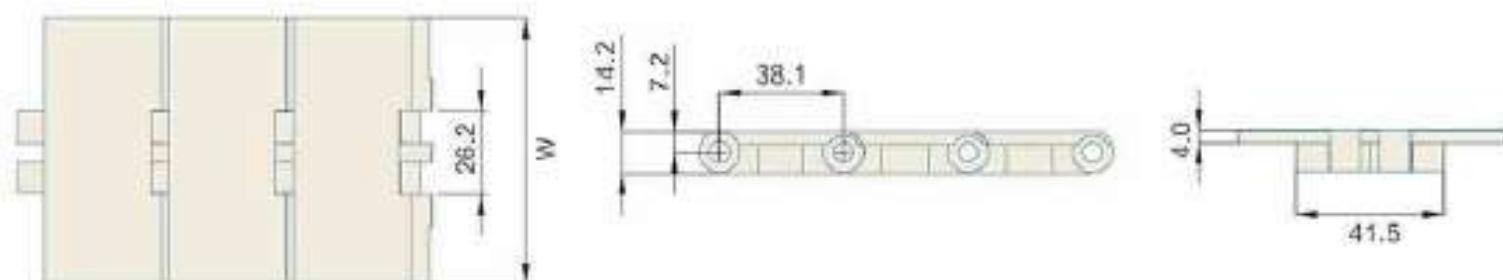

型号 Type No.	宽度 Width (mm)	节距 Pitch (mm)	重量 Weight (Kg/m)	负载 Working Capacity (N)
Har820-K250	63.5	38.1	0.69	1230
Har820-K325	82.8	38.1	0.89	1230
Har820-K350	88.9	38.1	0.91	1230
Har820-K400	101.6	38.1	0.93	1230
Har820-K450	114.3	38.1	1.06	1230
Har820-K600	152.4	38.1	1.30	1230
Har820-K750	190.5	38.1	1.51	1230

链轮 Sprocket	护栏 Guide	弯轨 Guide Rails	其余配件 Component
S12-S13	R01-R42	—	C01-C57

Har828 STRAIGHT TOP CHAINS

TOP CHAINS 828
P=38.1mm, T=15.1mm
PIN:Stainless steel

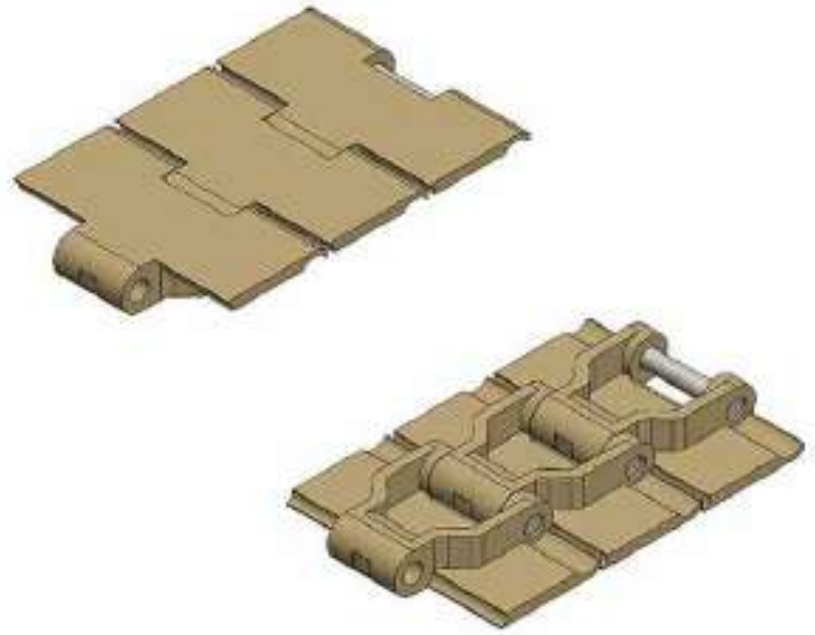

节距 Pitch	链板材质 Material	颜色 Color
38.1mm	POM	咖啡色/Brown

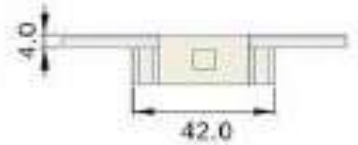
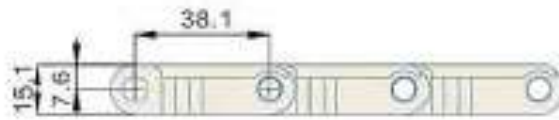
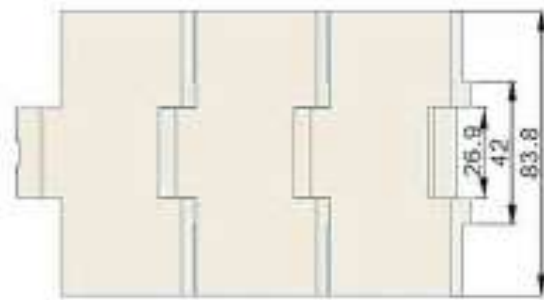

型号 Type No.	宽度 Width (mm)	节距 Pitch (mm)	重量 Weight (Kg/m)	负载 Working Capacity (N)
Har828-K330	83.8	38.1	1.08	2000

链轮 Sprocket	护栏 Guide	导轨 Guide Rails	其余配件 Component
S17-S18	R01-R42	—	C01-C57

Har821 Series Straight TOP CHAINS

TOP CHAINS 821 Series
P=38.1mm, T=14.3mm
PIN:Stainless steel

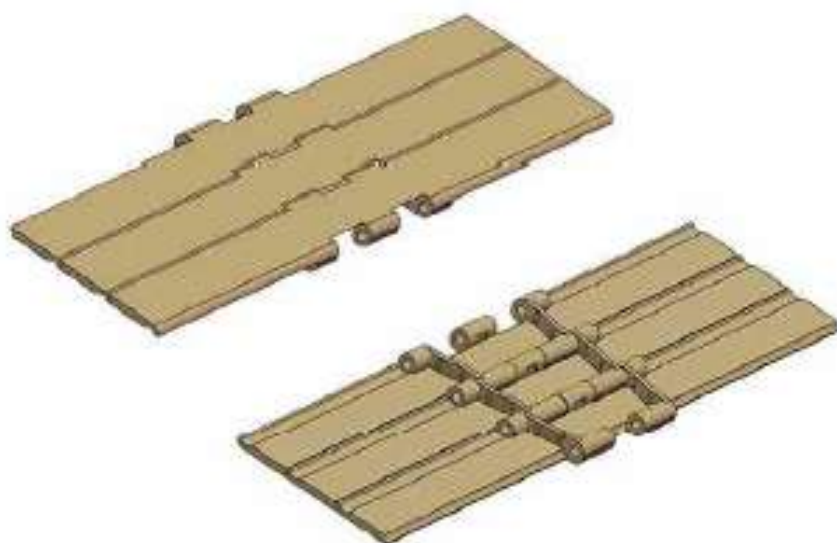

节距 Pitch	链板材质 Material	颜色 Color
38.1mm	POM	—

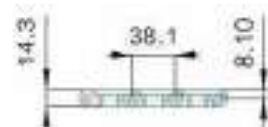
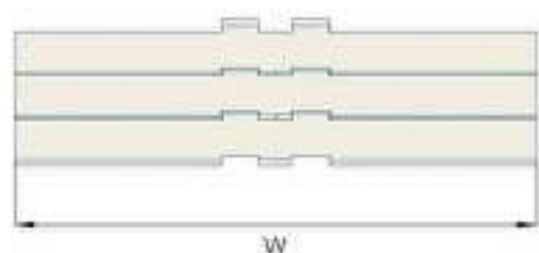

型号 Type No.	宽度 Width (mm)	节距 Pitch (mm)	重量 Weight (Kg/m)	负载 Working Capacity (N)
Har821-K750	190.5	38.1	2.48	2680
Har821-K1000	254.0	38.1	2.82	2680
Har821-K1200	304.8	38.1	3.12	2680
Har821-K1800	457.2	38.1	3.98	2680

链轮 Sprocket	护栏 Guide	弯轨 Guide Rails	其余配件 Component
S14-S16	R01-R42	—	C01-C57

Har880 CURVE

TOP CHAINS

TOP CHAINS 880

P=38.1mm, T=20mm

PIN:Stainless steel

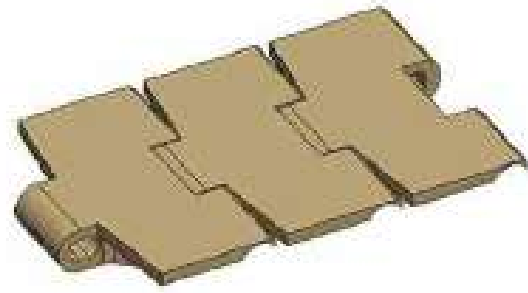

节距 Pitch	链板材质 Material	颜色 Color
38.1mm	POM	咖啡色/Brown

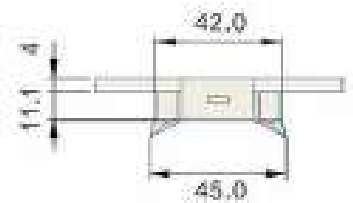
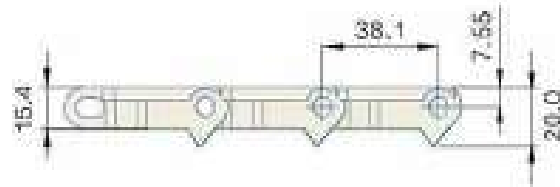
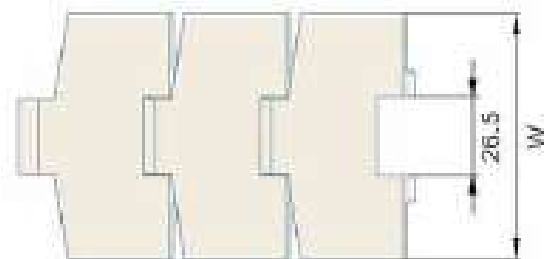

型号 Type No.	宽度 Width (mm)	节距 Pitch (mm)	重量 Weight (Kg/m)	转弯半径 Radius (mm)	负载 Working Capacity (N)
Har880-K325	82.6	38.1	0.9	510	2000

链轮 Sprocket	护栏 Guide	弯轨 Guide Rails	其余配件 Component
S17-S18	R01-R42	G03-G04	C01-C57

Har880M CURVE

TOP CHAINS

TOP CHAINS 880M

P=38.1mm, T=14.8mm

PIN:Stainless steel



节距 Pitch	链板材质 Material	颜色 Color
38.1mm	POM	咖啡色/Brown



型号 Type No.	宽度 Width (mm)	节距 Pitch (mm)	重量 Weight (Kg/m)	转弯半径 Radius (mm)	负载 Working Capacity (N)
Har880M-K325	82.6	38.1	0.98	510	2000
Har880M-K450	114.3	38.1	1.12	510	2000

链轮 Sprocket	护栏 Guide	弯轨 Guide Rails	其余配件 Component
S17-S18	R01-R42	G03	C01-C57

Har880TAB CURVE

TOP CHAINS

TOP CHAINS 880TAB
 P=38.1mm, T=19.9mm
 PIN:Stainless steel

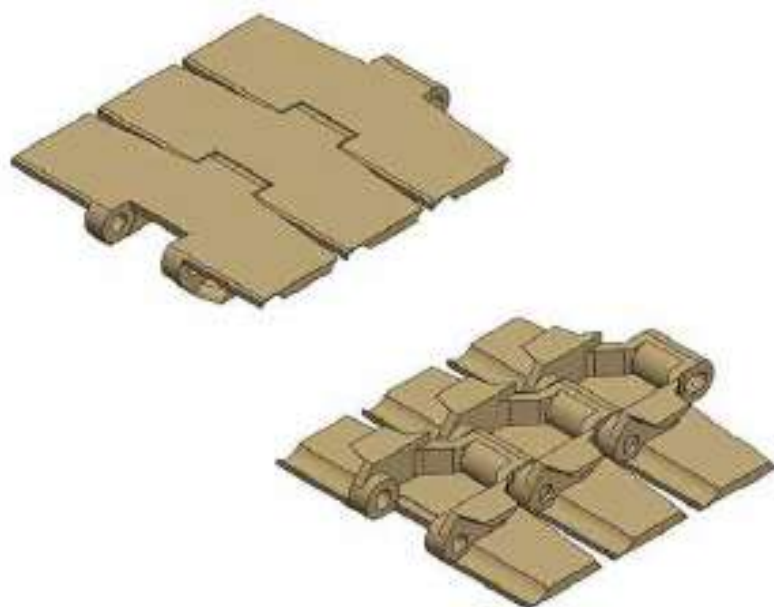

节距 Pitch	链板材质 Material	颜色 Color
38.1mm	POM	咖啡色/Brown

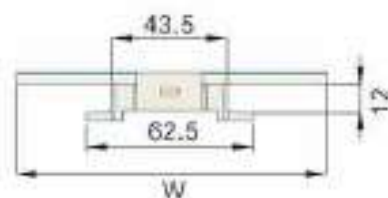
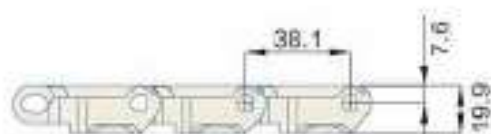
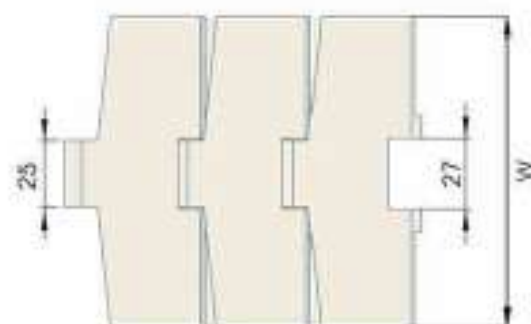

型号 Type No.	宽度 Width (mm)	节距 Pitch (mm)	重量 Weight (Kg/m)	转弯半径 Radius (mm)	负载 Working Capacity (N)
Har880TAB-K325	82.6	38.1	1.05	510	2000
Har880TAB-K450	114.3	38.1	1.24	510	2000

链轮 Sprocket	护栏 Guide	弯轨 Guide Rails	其余配件 Component
S17-S18	R01-R42	G01-G02	C01-C57

Har882M Series Curve

TOP CHAINS

TOP CHAINS 882

P=38.1mm, T=19mm

PIN:Stainless steel

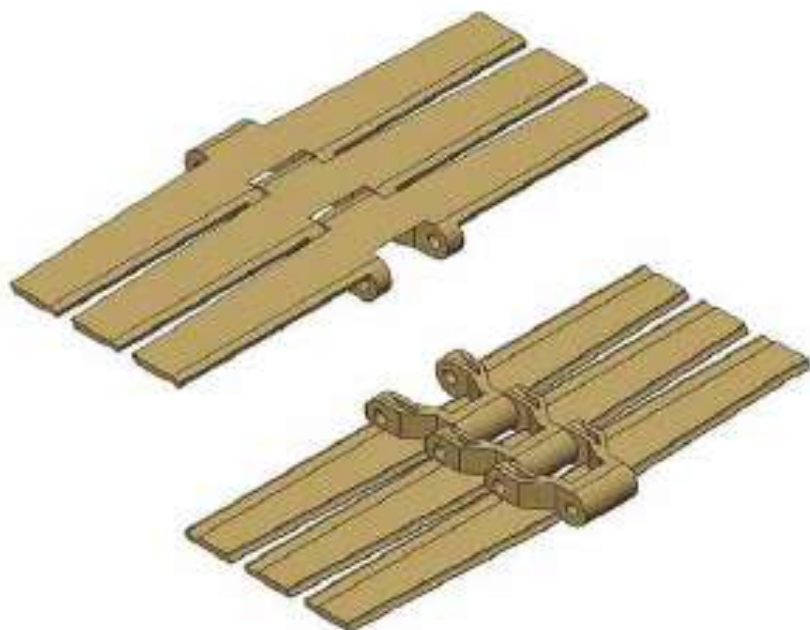

节距 Pitch	链板材质 Material	颜色 Color
38.1mm	POM	棕色/Brown

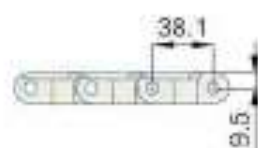
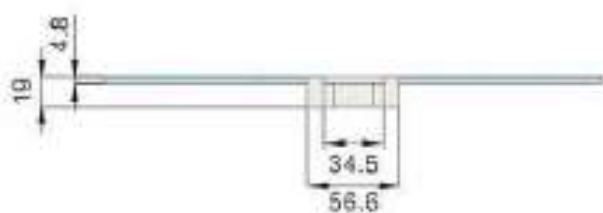
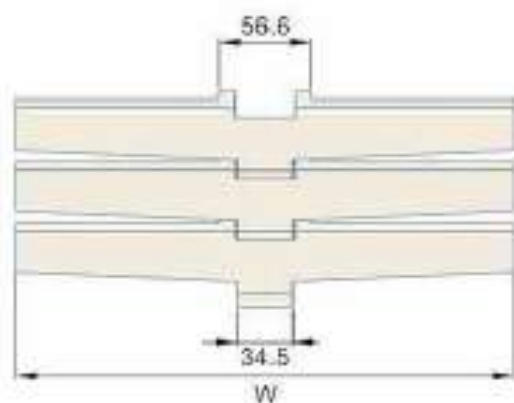

型号 Type No.	宽度 Width (mm)	节距 Pitch (mm)	重量 Weight (Kg/m)	转弯半径 Radius (mm)	负载 Working Capacity (N)
Har882M-K450	114.3	38.1	1.19	610mm	3830
Har882M-K600	152.4	38.1	1.78	610mm	3830
Har882M-K750	190.5	38.1	2.16	610mm	3830
Har882M-K1000	254.0	38.1	2.35	610mm	3830
Har882M-K1200	304.8	38.1	2.65	610mm	3830

链轮 Sprocket	护栏 Guide	弯轨 Guide Rails	其余配件 Component
S19-S20	R01-R42	—	C01-C57

Har882 Series Straight TOP CHAINS

TOP CHAINS 882

P=38.1mm, T=19mm

PIN:Stainless steel

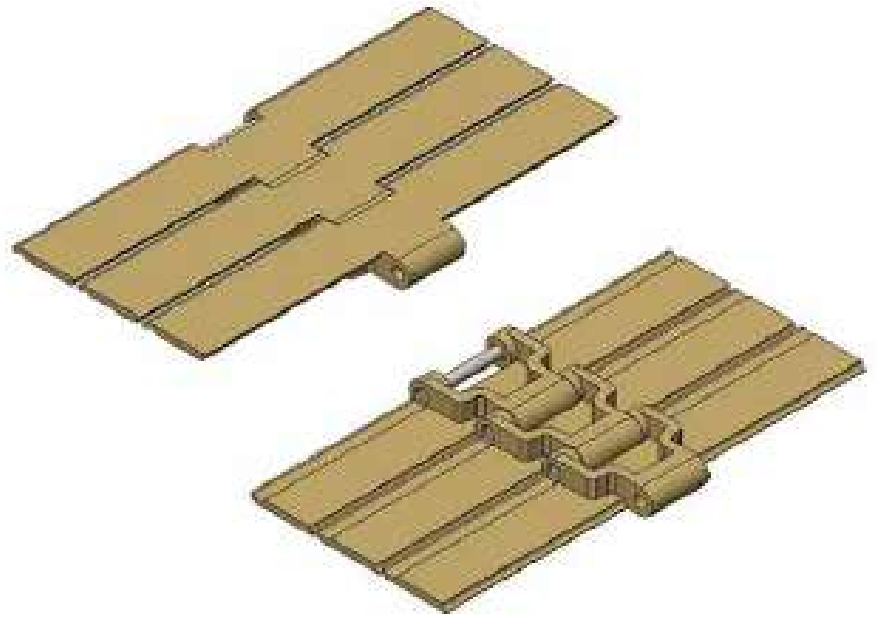

节距 Pitch	链板材质 Material	颜色 Color
38.1mm	POM	棕色/Brown

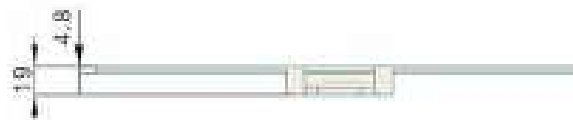
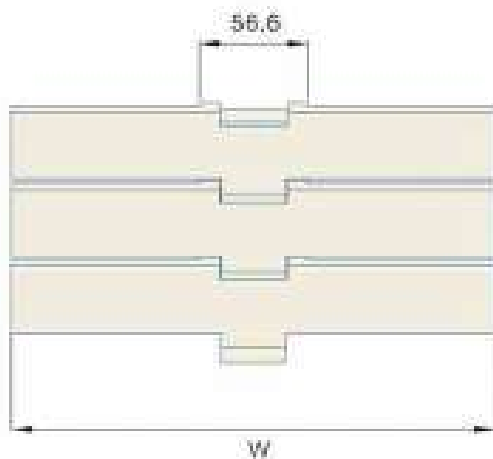

型号 Type No.	宽度 Width (mm)	节距 Pitch (mm)	重量 Weight (Kg/m)	负载 Working Capacity (N)
Har882-K750	190.5	38.1	2.16	3910
Har882-K1000	254.0	38.1	2.35	3910

链轮 Sprocket	护栏 Guide	导轨 Guide Rails	其余配件 Component
S19-S20	R01-R42	—	C01-C57

Har515 Series

TOP CHAINS

MULTIFLEX CHAINS 515 Series
 P=25.4 mm, T=13mm
 PIN:Stainless steel

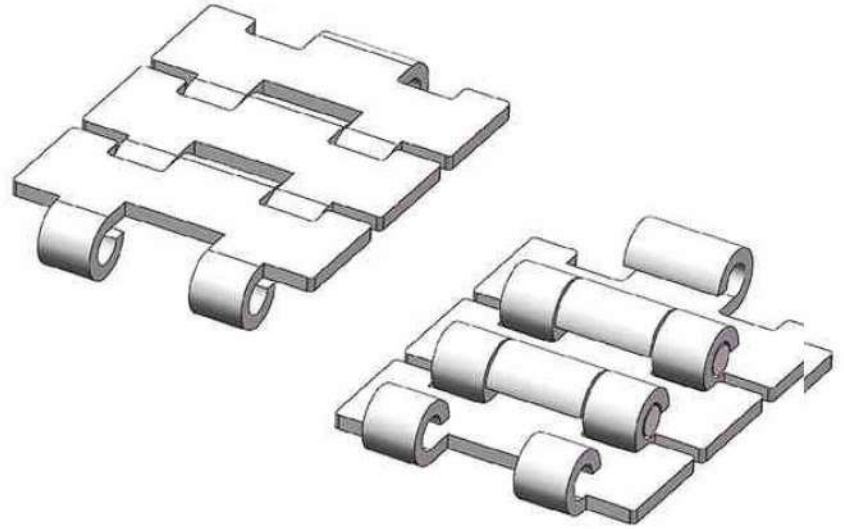

节距 Pitch	链板材质 Material
25.4mm	SS304/2CR13

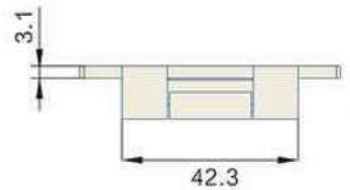
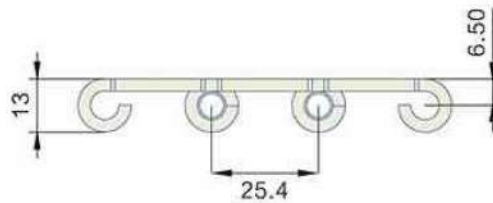
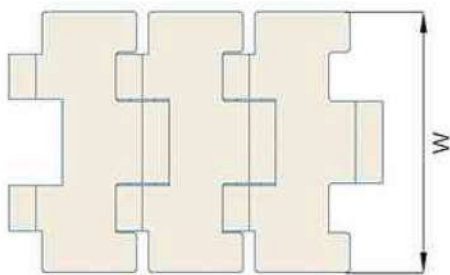

型号 Type No.	宽度 Width (mm)	节距 Pitch (mm)	重量 Weight (Kg/m)	转弯半径 Radius (mm)	负载 Working Capacity (N)
Har515k-197	50.0	25.4	2.10	—	4000
Har515k-217	55.0	25.4	2.30	—	4000
Har515k-236	60.0	25.4	2.45	—	4000
Har515k-283	72.0	25.4	2.80	—	4000

链轮 Sprocket	护栏 Guide	弯轨 Guide Rails	其余配件 Component
S06	R01-R42	—	C01-C57

Har802 Series

TOP CHAINS

TOP CHAINS 802
 P=38.1mm, T=3mm
 OPEN AREA:0%

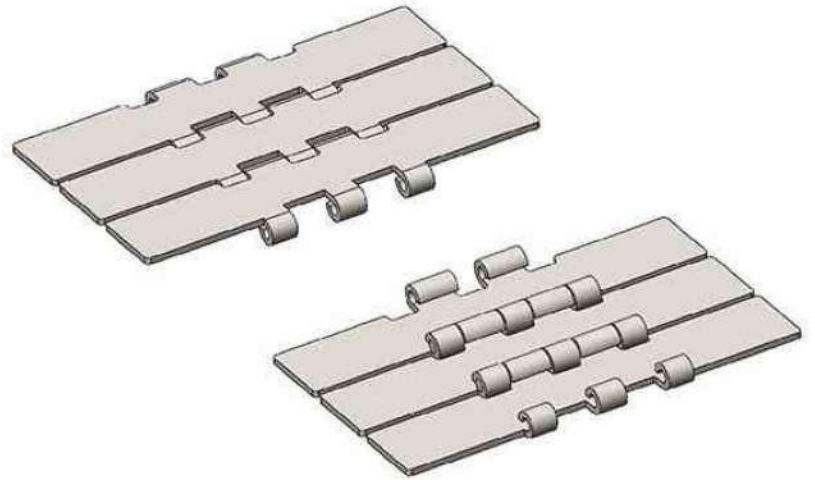

节距 Pitch	链板材质 Material
38.1mm	SS304/2CR13

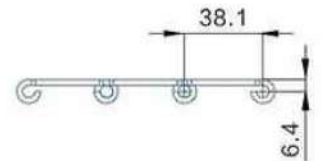
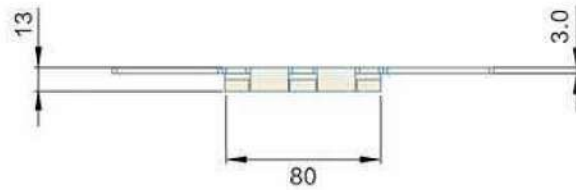
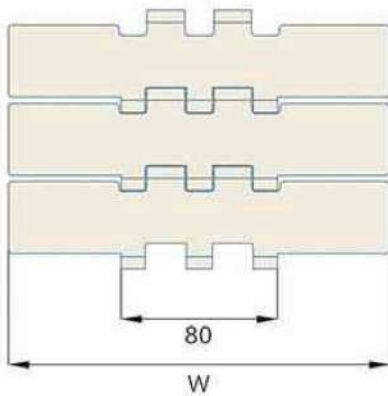

型号 Type No.	宽度 Width (mm)	节距 Pitch (mm)	重量 Weight (Kg/m)	转弯半径 Radius (mm)	负载 Working Capacity (N)
Har802-K750	190.5	38.1	5.61	—	10600
Har802-K1000	254.0	38.1	7.48	—	10600
Har802-K1200	304.8	38.1	9.00	—	10600

链轮 Sprocket	护栏 Guide	弯轨 Guide Rails	其余配件 Component
S14-S15	R01-R42	—	C01-C57

Har812 Series

TOP CHAINS

TOP CHAINS 812 Series
 P=38.1mm, T=13mm
 PIN:Stainless steel

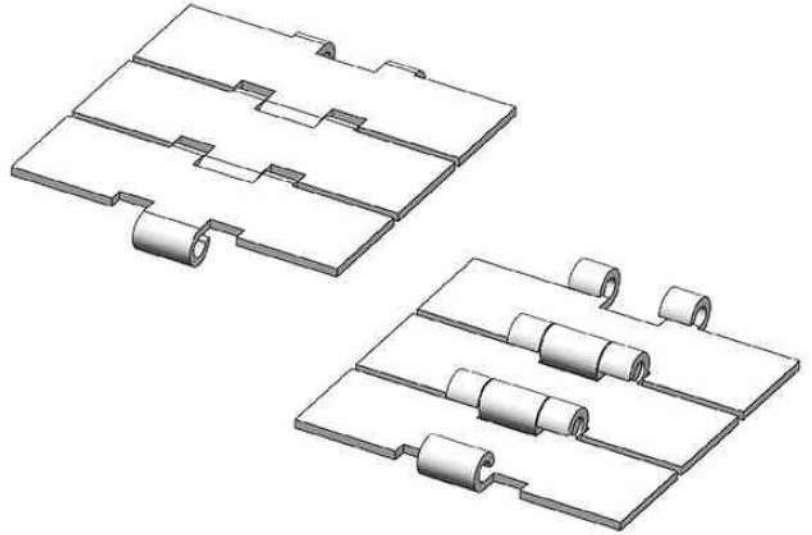

节距 Pitch	链板材质 Material
38.1mm	SS304/2CR13

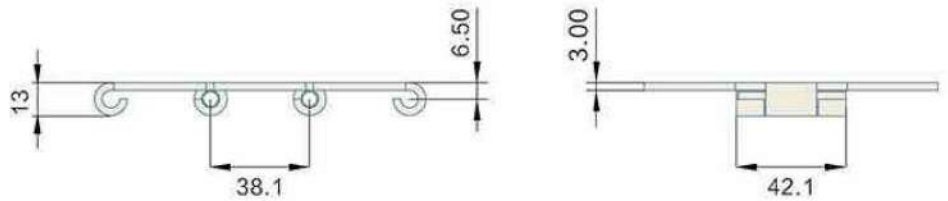
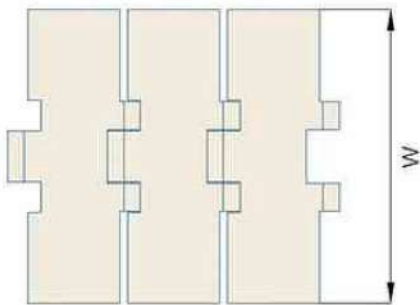

型号 Type No.	宽度 Width (mm)	节距 Pitch (mm)	重量 Weight (Kg/m)	转弯半径 Radius (mm)	负载 Working Capacity (N)
Har812-k250	63.5	38.1	1.55	—	4000
Har812-k325	82.6	38.1	2.86	—	4000
Har812-k450	114.3	38.1	3.50	—	4000
Har812-k600	152.4	38.1	4.40	—	4000
Har812-k750	190.5	38.1	5.20	—	4000

链轮 Sprocket	护栏 Guide	弯轨 Guide Rails	其余配件 Component
S09-S11	R01-R42	G01	C01-C57

Har981M Series

TOP CHAINS

TOP CHAINS 981M
 P=38.1mm, T=3mm
 OPEN AREA:0%

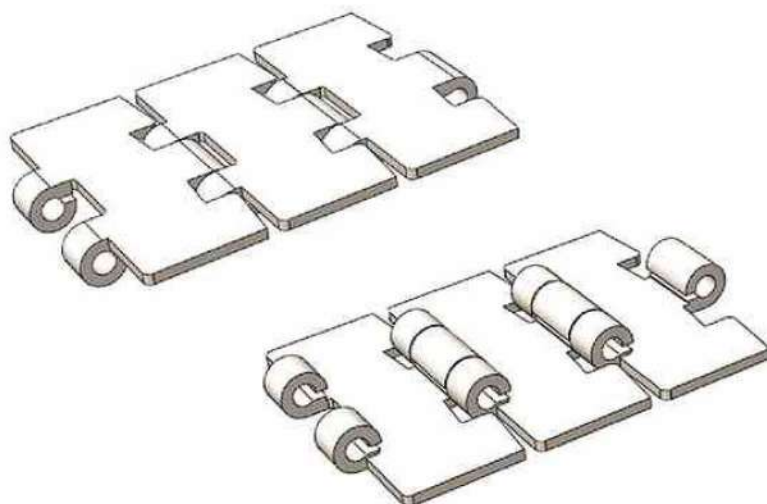

节距 Pitch	链板材质 Material
38.1mm	SS304/2CR13

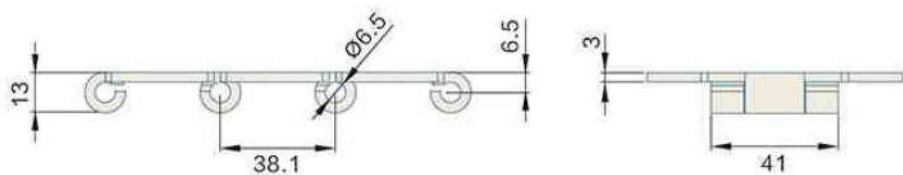
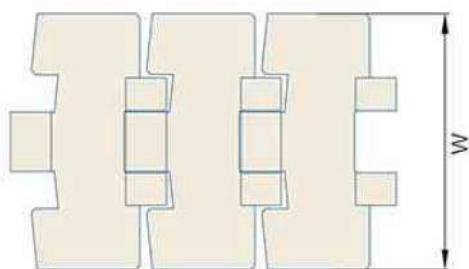

型号 Type No.	宽度 Width (mm)	节距 Pitch (mm)	重量 Weight (Kg/m)	转弯半径 Radius (mm)	负载 Working Capacity (N)
Har981M-K325	82.6	38.1	2.5	610	5400
Har981M-K450	114.3	38.1	3.1	610	5400
Har981M-K750	190.5	38.1	4.5	610	5400

链轮 Sprocket	护栏 Guide	弯轨 Guide Rails	其余配件 Component
S23	R01-R42	G06	C01-C57

Har843 ROLLER CHAINS

ROLLER CHAINS

ROLLER CHAINS 843

P=12.7mm, T=11mm

OPEN AREA:0%



节距 Pitch	链板材质 Material
12.7mm	SS304

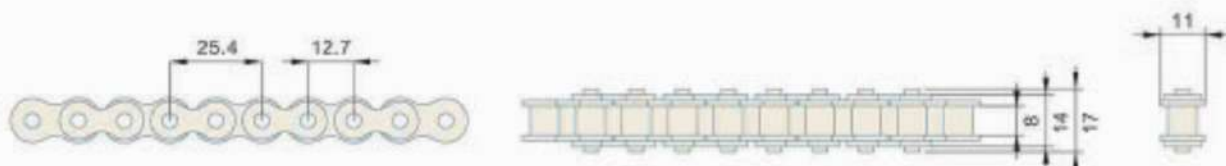

型号 Type No.	销轴长度 Length (mm)	节距 Pitch (mm)	重量 Weight (Kg/m)	转弯半径 Radius (mm)	负载 Working Capacity (N)
Har843	17	12.7	0.85	—	2000

链轮 Sprocket	护栏 Guide	弯轨 Guide Rails	其余配件 Component
S17	R01-R42	—	C01-C57

Har843 Series TOP CHAINS

TOP CHAINS 843 Series
P=25.4mm, T=14.3mm
PIN:Stainless steel

节距 Pitch	链板材质 Material	颜色 Color
25.4mm	POM	棕色/Brown

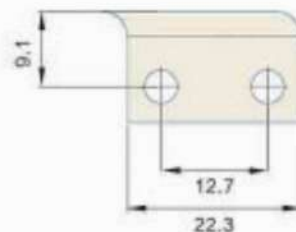
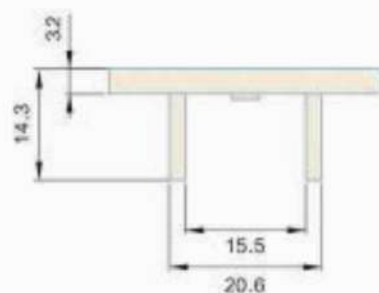
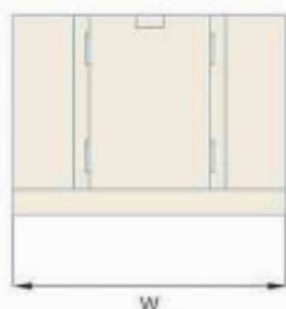
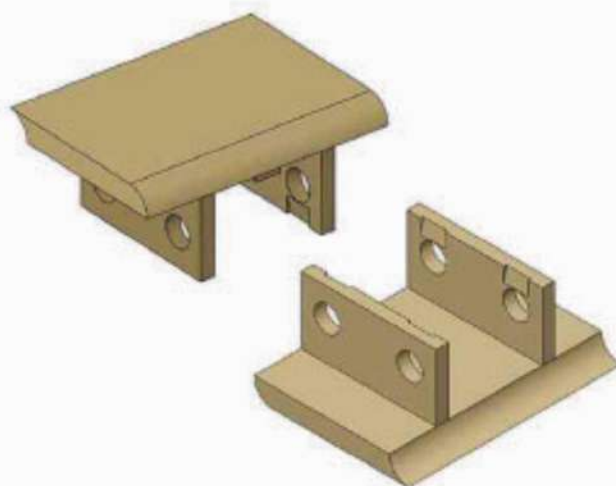

型号 Type No.	宽度 Width (mm)	节距 Pitch (mm)	重量 Weight (Kg/m)	负载 Working Capacity (N)
Har843-K138	34.9	25.4	0.69	2430
Har843-K200	50.8	25.4	0.75	2430
Har843-K325	82.6	25.4	0.82	2430

链轮 Sprocket	护栏 Guide	弯轨 Guide Rails	其余配件 Component
S17	R01-R42	—	C01-C57

Har845 Curve TOP CHAINS

TOP CHAINS 845
P=25.4mm, T=3.2mm
PIN:Stainless steel

节距 Pitch	链板材质 Material	颜色 Color
25.4mm	POM	咖啡色/Brown

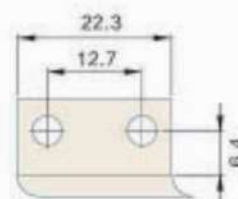
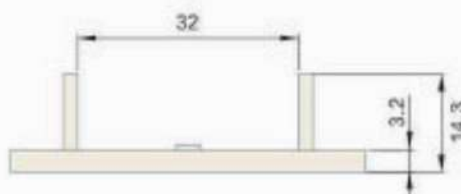
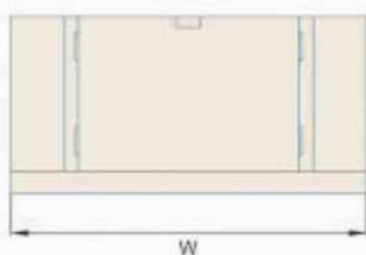
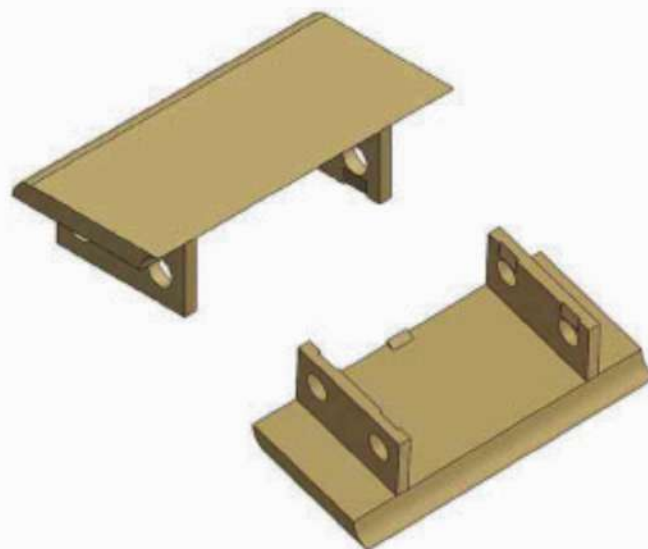

型号 Type No.	宽度 Width (mm)	节距 Pitch (mm)	重量 Weight (Kg/m)	负载 Working Capacity (N)
Har845-K138	34.9	25.4	0.84	2700
Har845-k200	50.8	25.4	0.90	2700
Har845-K325	82.6	25.4	1.03	2700

链轮 Sprocket	护栏 Guide	弯轨 Guide Rails	其余配件 Component
S17	R01-R42	—	C01-C57

Har1873/963 Series ROLLER CHAINS

ROLLER CHAINS 1873/963
P=19.05mm, T=18mm

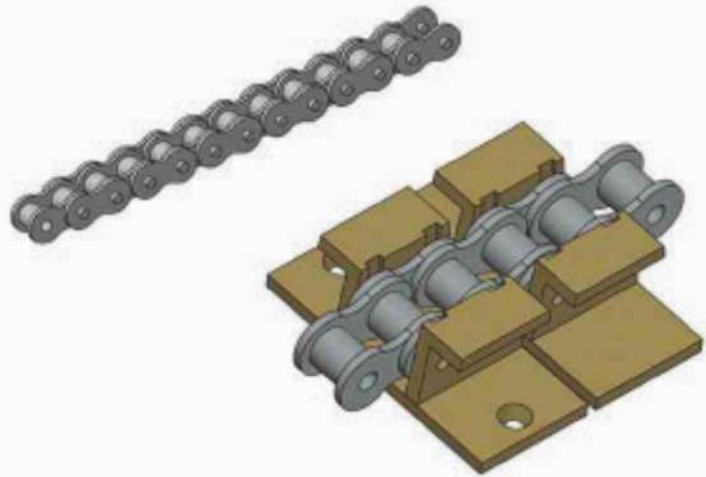

节距 Pitch	不锈钢材质 Material
19.05mm	SS304

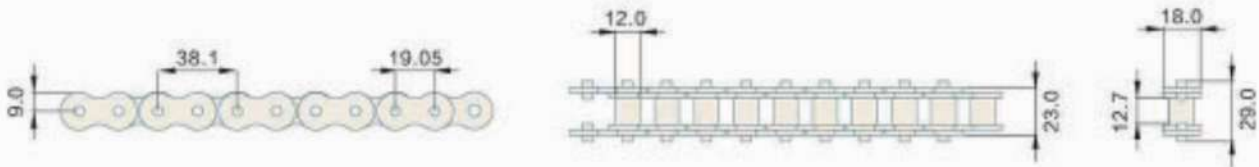

型号 Type No.	销轴长度 Length (mm)	节距 Pitch (mm)	重量 Weight (Kg/m)	侧转弯半径 Radius (mm)	负载 Working Capacity (N)
Har1873/963	29	19.05	2.1	810	2560

链轮 Sprocket	护栏 Guide	弯轨 Guide Rails	其余配件 Component
S35	R01-R42	—	C01-C57

Har963TAB Series Straight TOP CHAINS

TOP CHAINS 963TAB Series
P=38.1mm, T=4mm
PIN: Stainless Steel

节距 Pitch	链板材质 Material	颜色 Color
38.1mm	POM	棕色/Brown

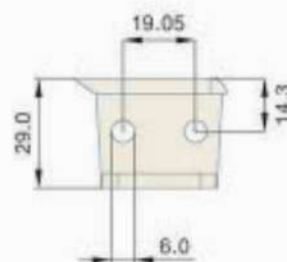
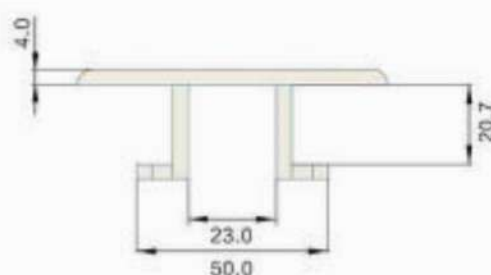
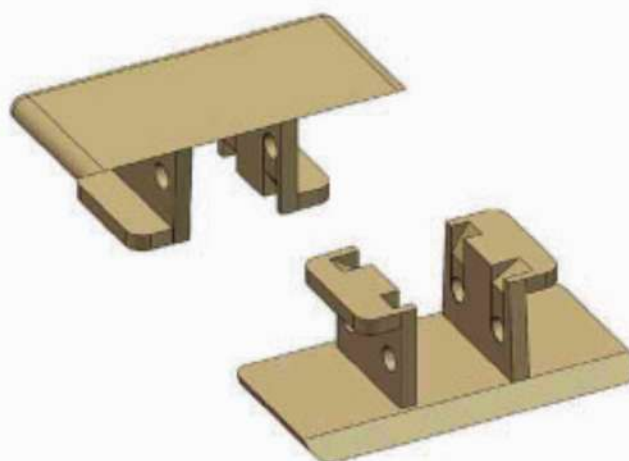

型号 Type No.	宽度 Width (mm)	节距 Pitch (mm)	重量 Weight (Kg/m)	负载 Working Capacity (N)
Har963TAB-K325	82.6	38.1	0.69	2560
Har963TAB-K450	114.3	38.1	0.75	2560
Har963TAB-K1000	254.0	38.1	1.10	2560

链轮 Sprocket	护栏 Guide	弯轨 Guide Rails	其余配件 Component
S35	R01-R42	G08	C01-C57

Har963 Series Straight TOP CHAINS

TOP CHAINS 963
P=38.1mm, T=22mm

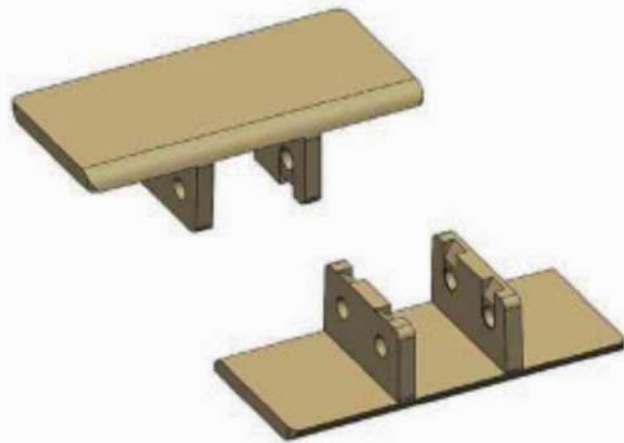

节距 Pitch	链板材质 Material	颜色 Color
38.1mm	POM	棕色/Brown

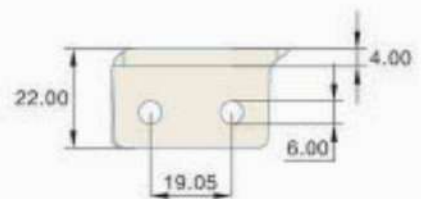
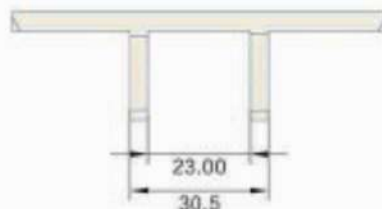

型号 Type No.	宽度 Width (mm)	节距 Pitch (mm)	重量 Weight (Kg/m)	负载 Working Capacity (N)
Har963-K325	82.6	38.1	2.10	4400
Har963-K450	114.3	38.1	2.30	4400
Har963-K1000	254.0	38.1	3.17	4400

链轮 Sprocket	护栏 Guide	弯轨 Guide Rails	其余配件 Component
S35	R01-R42	G08	C01-C57

Har1873-E Curve

TOP CHAINS

TOP CHAINS 1873-E
 P=38.1mm, T=6mm
 PIN:Stainless steel

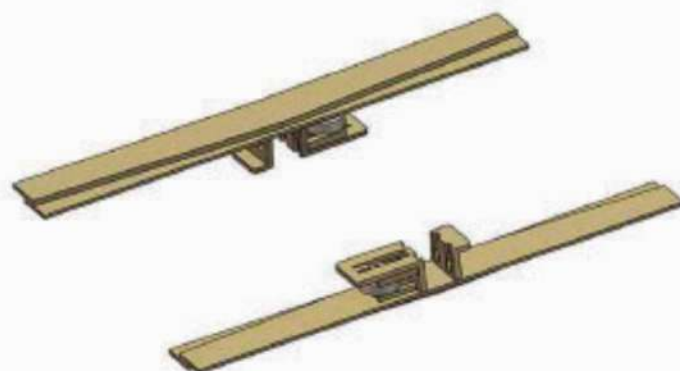

节距 Pitch	链板材质 Material	颜色 Color
38.1mm	POM	棕色/Brown

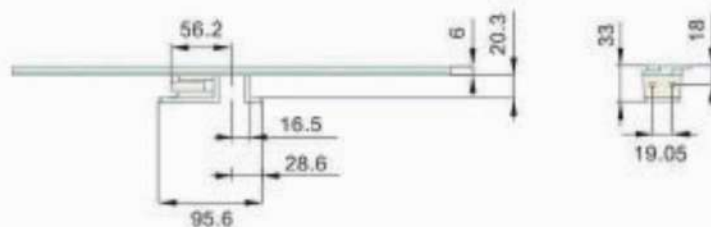

型号 Type No.	宽度 Width (mm)	节距 Pitch (mm)	重量 Weight (Kg/m)	负载 Working Capacity (N)
Har1873-E-K1000	254.0	38.1	4.30	3200
Har1873-E-K1200	304.8	38.1	4.70	3200

链轮 Sprocket	护栏 Guide	弯轨 Guide Rails	其余配件 Component
S35	R01-R42	G08	C01-C57

Har1873TAB Series Curve

TOP CHAINS

TOP CHAINS 1873TAB Series
 P=38.1mm, T=29mm
 PIN:Stainless steel

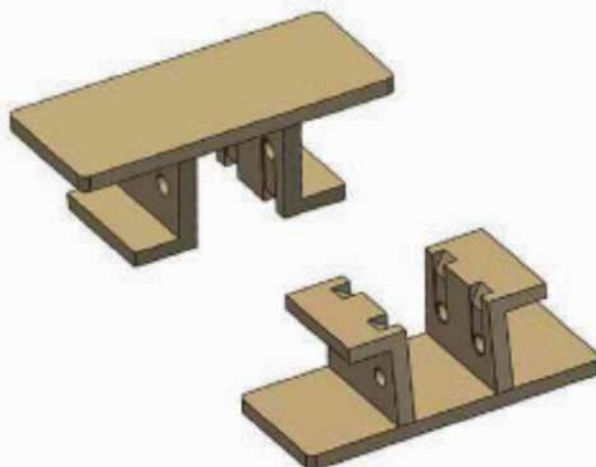

节距 Pitch	链板材质 Material	颜色 Color
38.1mm	POM	棕色/Brown

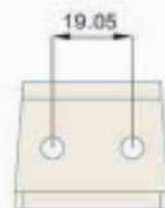
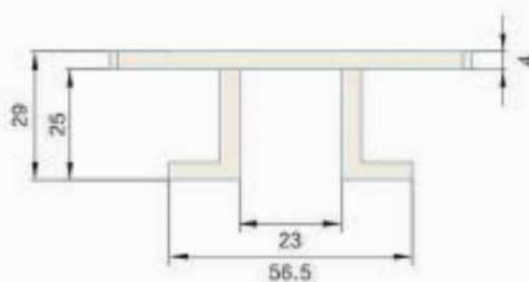

型号 Type No.	宽度 Width (mm)	节距 Pitch (mm)	重量 Weight (Kg/m)	负载 Working Capacity (N)
Har1873-K325	82.6	38.1	2.10	2560
Har1873-K450	114.3	38.1	2.26	2560
Har1873-K600	152.4	38.1	2.41	2560
Har1873-K750	190.5	38.1	2.56	2560
Har1873-K1000	254.0	38.1	2.78	2560
Har1873-K1200	304.8	38.1	3.01	2560

链轮 Sprocket	护栏 Guide	弯轨 Guide Rails	其余配件 Component
S35	R01-R42	G08	C01-C57