



## Bar caps & Wear strips

**BK-HS-EX25**

**BK-HS-U1**

**BK-HS-T4**

**BK-HS-EX98**

**BK-H-D548**

specification		specification	
L	T	L	T
20	4	40	4
35	6	45	3
42	3	50	5
70	5	50	4
90	6	50	3
140	4	110	3

## Bar caps & Wear strips

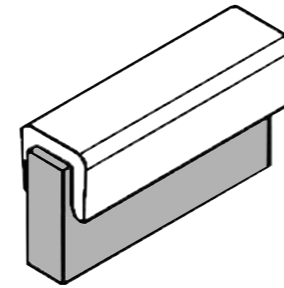

These low friction, wear resistant UHMW caps are designed to clip onto various thicknesses of flat bar material. Applications include conveyor belt supporting and conveyor side or neck guides.

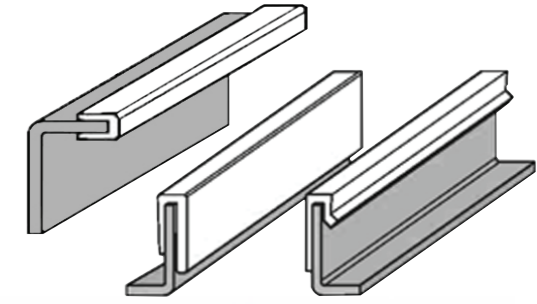

Can be used as side guidirs

### BK - UHMW / PP - 3BC

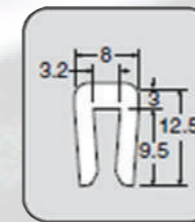
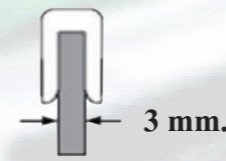

### BK - UHMW / PP - 4BC

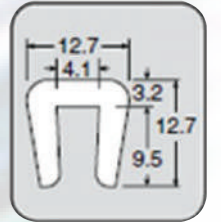
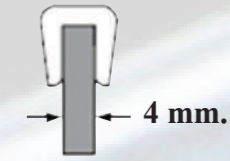

### BK - UHMW / PP - 14BC

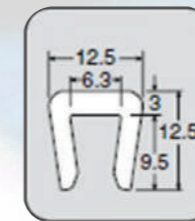
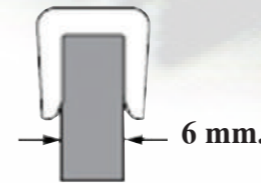

### BK - UHMW / PP - 38BC

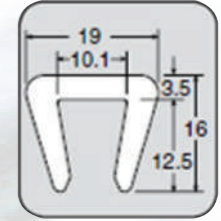
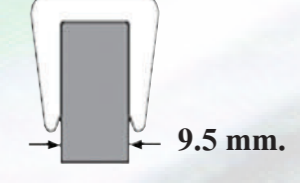

### BK - UHMW / PP - R95

